

Wire Wound Chip Balun Transformer – BW Series

Operating Temp. : -40°C ~+ 85°C



FEATURES

- Winding structure and small size
- Surface mount type
- Low insertion loss at frequency range
- Excellent solderability

APPLICATIONS

- Balanced unbalanced transformation between antenna and cable (TV tuner)

PRODUCT IDENTIFICATION

B ①	W ②	21 ③	S ④	75 ⑤	11 ⑥	A01 ⑦	T ⑧	F ⑨															
<table border="1"> <tr><th colspan="2">Type</th></tr> <tr><td>B</td><td>Chip Balun Transformer</td></tr> </table>		Type		B	Chip Balun Transformer	<table border="1"> <tr><th colspan="2">Structure</th></tr> <tr><td>W</td><td>Winding Type</td></tr> </table>		Structure		W	Winding Type	<table border="1"> <tr><th colspan="2">External Dimensions (LxW) (mm)</th></tr> <tr><td>21</td><td>2.0x1.2</td></tr> <tr><td>43</td><td>4.5x3.2</td></tr> </table>		External Dimensions (LxW) (mm)		21	2.0x1.2	43	4.5x3.2				
Type																							
B	Chip Balun Transformer																						
Structure																							
W	Winding Type																						
External Dimensions (LxW) (mm)																							
21	2.0x1.2																						
43	4.5x3.2																						
<table border="1"> <tr><th colspan="2">Type of Transformer</th></tr> <tr><td>S</td><td>Standard</td></tr> <tr><td>C</td><td>Internal Code</td></tr> </table>		Type of Transformer		S	Standard	C	Internal Code	<table border="1"> <tr><th colspan="2">Port Impedance</th></tr> <tr><td>75</td><td>75Ω</td></tr> <tr><td>50</td><td>50Ω</td></tr> </table>		Port Impedance		75	75Ω	50	50Ω	<table border="1"> <tr><th colspan="2">Impedance Ratio</th></tr> <tr><td>11</td><td>1:1</td></tr> <tr><td></td><td>One to One</td></tr> </table>		Impedance Ratio		11	1:1		One to One
Type of Transformer																							
S	Standard																						
C	Internal Code																						
Port Impedance																							
75	75Ω																						
50	50Ω																						
Impedance Ratio																							
11	1:1																						
	One to One																						
<table border="1"> <tr><th colspan="2">Characteristic Code</th></tr> <tr><td>A01</td></tr> <tr><td>B02</td></tr> <tr><td>C01</td></tr> <tr><td>D01</td></tr> <tr><td>E01</td></tr> </table>		Characteristic Code		A01	B02	C01	D01	E01	<table border="1"> <tr><th colspan="2">Packing</th></tr> <tr><td>T</td><td>Tape Carrier Package</td></tr> </table>		Packing		T	Tape Carrier Package	<table border="1"> <tr><th colspan="2">Hazardous Substance Free Products</th></tr> <tr><td>F</td></tr> </table>		Hazardous Substance Free Products		F				
Characteristic Code																							
A01																							
B02																							
C01																							
D01																							
E01																							
Packing																							
T	Tape Carrier Package																						
Hazardous Substance Free Products																							
F																							

SHAPE AND DIMENSIONS

BW21S Series

Land Pattern

Unit: mm

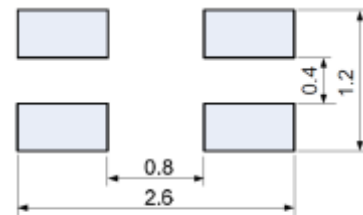
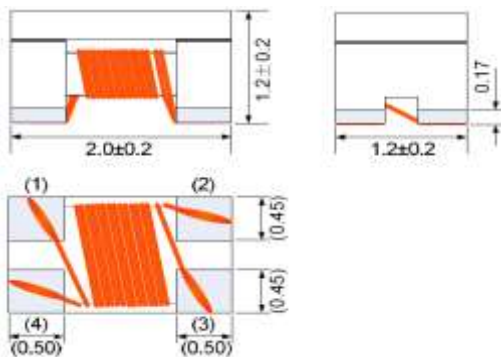

SHAPE AND DIMENSIONS

BW21C Series

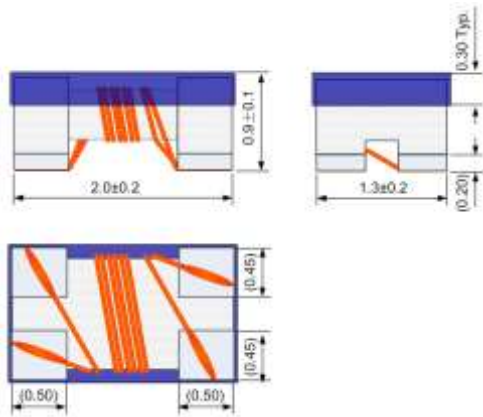

Land Pattern

Unit: mm

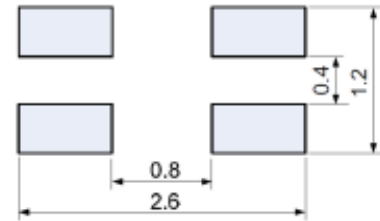

BW43S Series

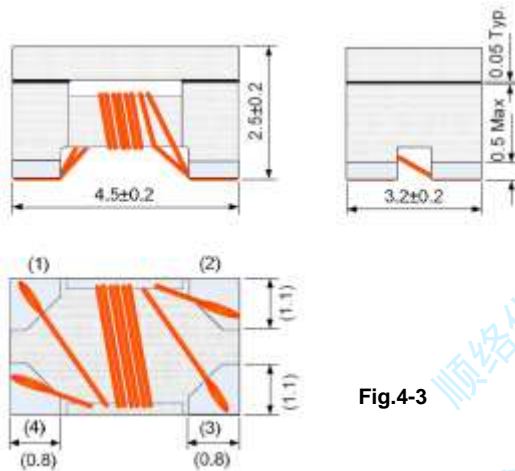

Land Pattern

Unit: mm

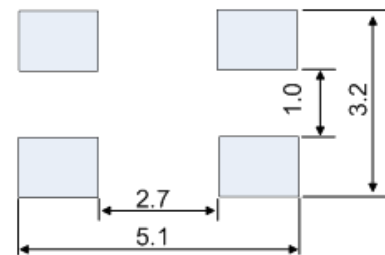

Fig.4-3

SPECIFICATIONS

BW21S TYPE

Part Number	Freq. Range	Port Impedance	Insertion Loss at Freq. Range	CMRR at Freq. Range(Min.)	Rated Power
Units	MHz	Ω	dB	dB	dBm
BW21S7511A01TF	45~870	75/75	1.0	20	27
BW21S5011A01TF	45~870	50/50	1.2	20	27
BW21S7511B02TF	50~1200	75/75	1.2	20	27
BW21S7511C01TF	1000~1500	75/75	1.4	20	27
BW21S7511D01TF	950~2150	75/75	1.5	20	27
BW21S7511E01TF	400~1800	75/75	2.0	10	27

BW21C TYPE

Part Number	Freq. Range	Port Impedance	Inductance	Insertion Loss	Return Loss	DC Resistance	Rated Current	CMRR	Insulation Resistance
Units	MHz	Ω	μ H	dB	dB	Ω	mA	dB	M Ω
BW21C2511A01TF	13.56	25/25	1.0 Min.	1.0 Max.	13 typ.	0.75 Max.	220 Min	47 Min.	10 Min.

SPECIFICATIONS

BW43S TYPE

Part Number	Freq. Range	Inductance @50MHz	Port Impedance	Insertion Loss	DC Resistance	Rated Current	Rated Voltage	Insulation Resistance (MΩ)
Units	MHz	uH	Ω	dB	Ω	mA	VDC	dB
BW43S5011C01TF	4~200	1.25 Typ	50/50	2.52 Typ	0.40 Max	540 Max	50	10 Min
BW43S5011E01TF	48~645	1.00 Typ	50/50	6.66 Typ	0.15 Max	960 Max	50	10 Min

※Products with other electrical characteristics can be provided upon customer's request. Please contact your local sales.

EQUIVALENT CIRCUIT

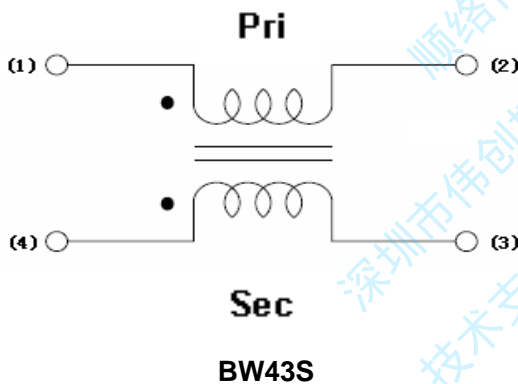
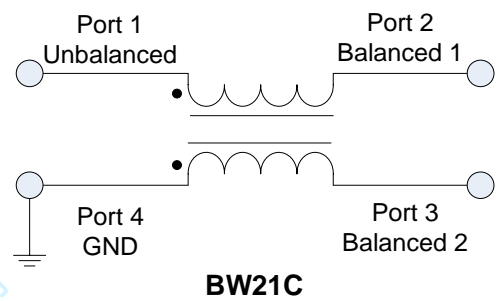
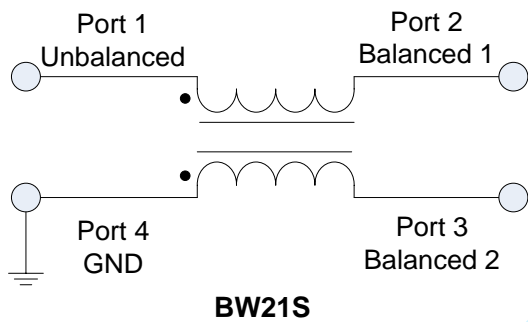

TYPICAL ELECTRICAL CHARACTERISTICS

BW21S7511A01TF

Insertion Loss Characteristics

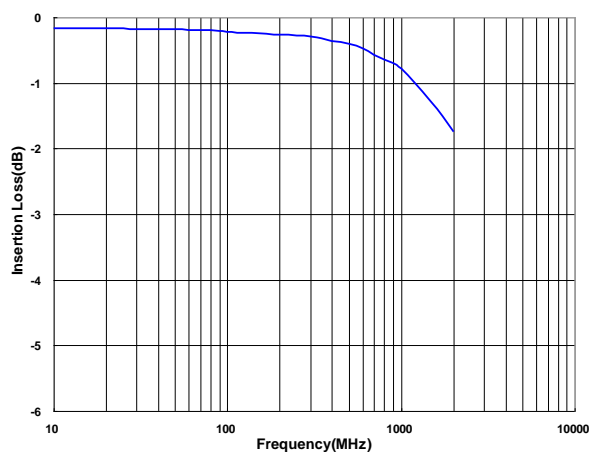

CMRR Characteristics

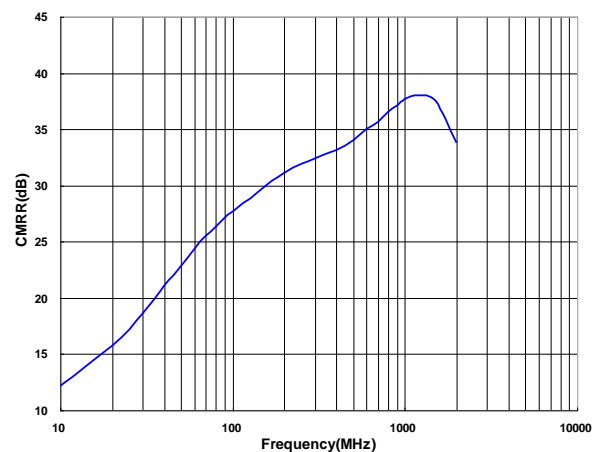

TYPICAL ELECTRICAL CHARACTERISTICS

BW21S5011A01TF

Insertion Loss Characteristics

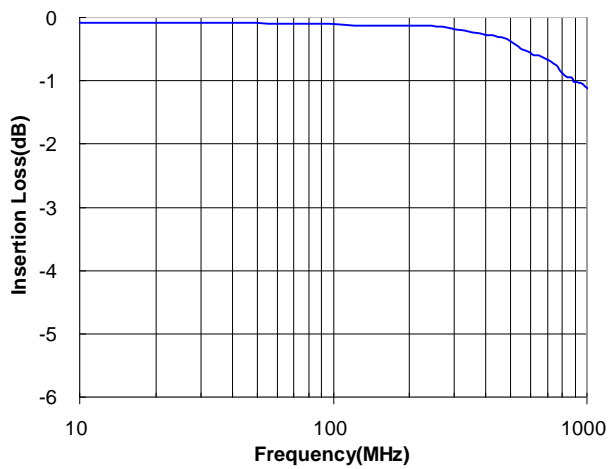

CMRR Characteristics

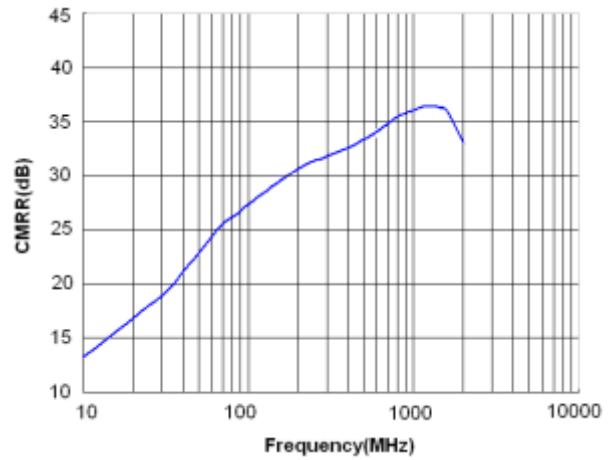

BW21S7511B02TF

Insertion Loss Characteristics

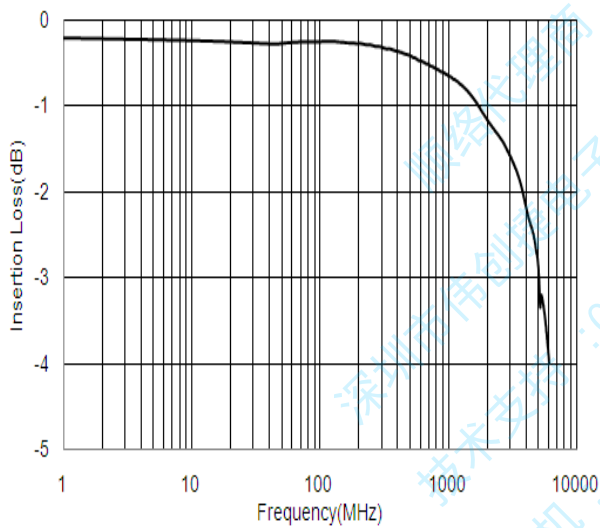

CMRR Characteristics

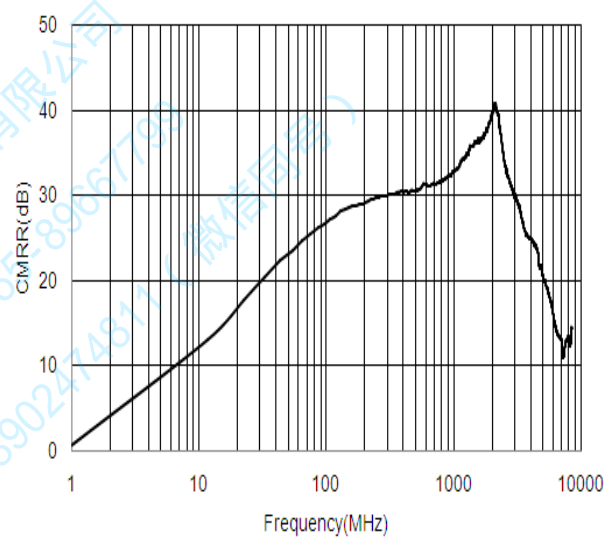

BW21S7511C01TF

Insertion Loss Characteristics

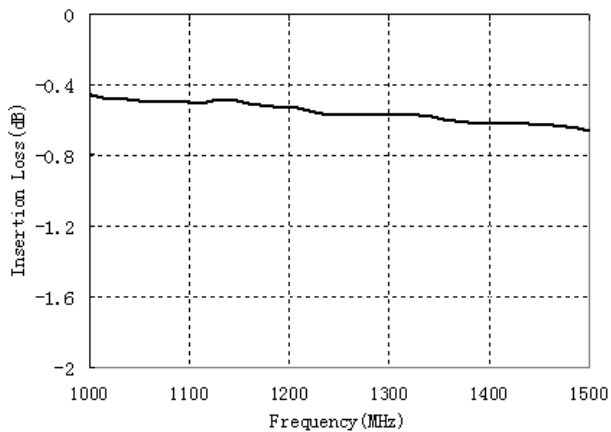

CMRR Characteristics

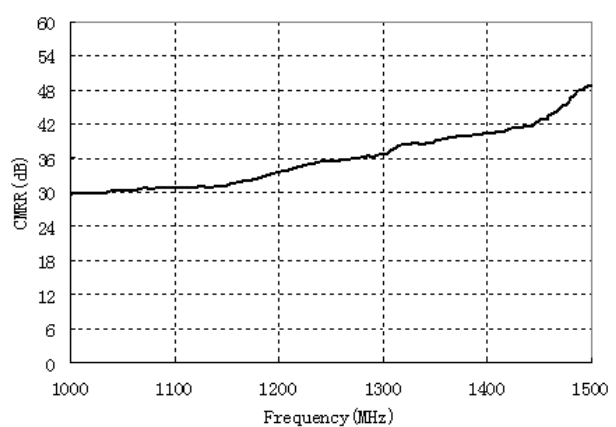

TYPICAL ELECTRICAL CHARACTERISTICS

BW21S7511D01TF

Insertion Loss Characteristics

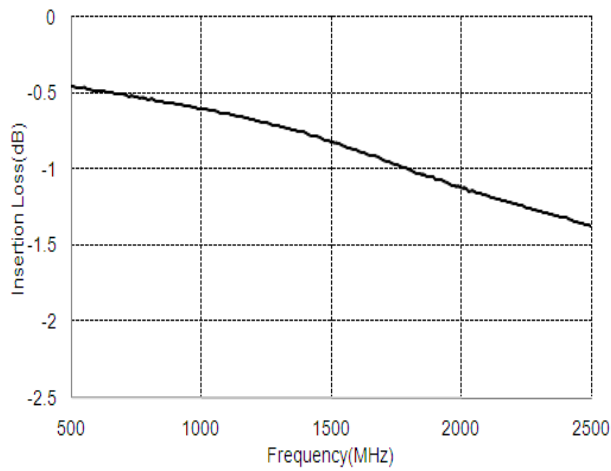

CMRR Characteristics

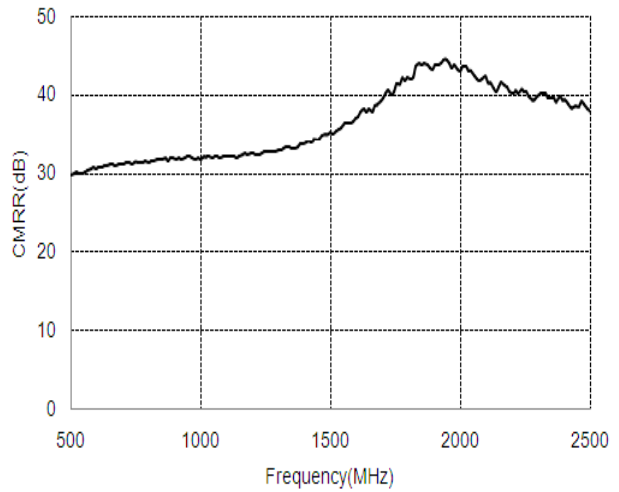

BW21S7511E01TF

Insertion Loss Characteristics

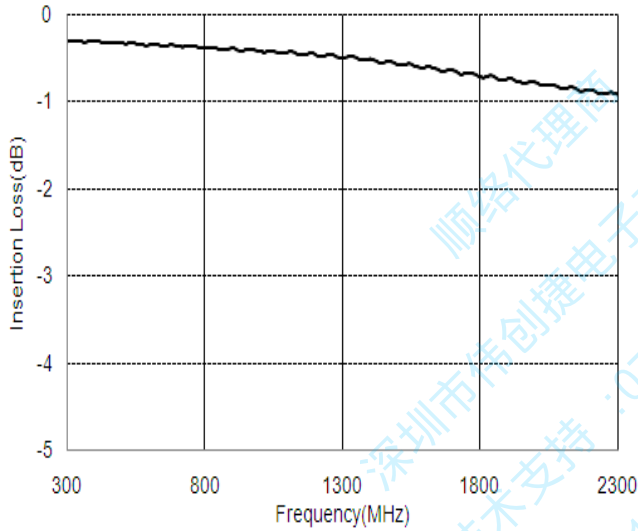

CMRR Characteristics

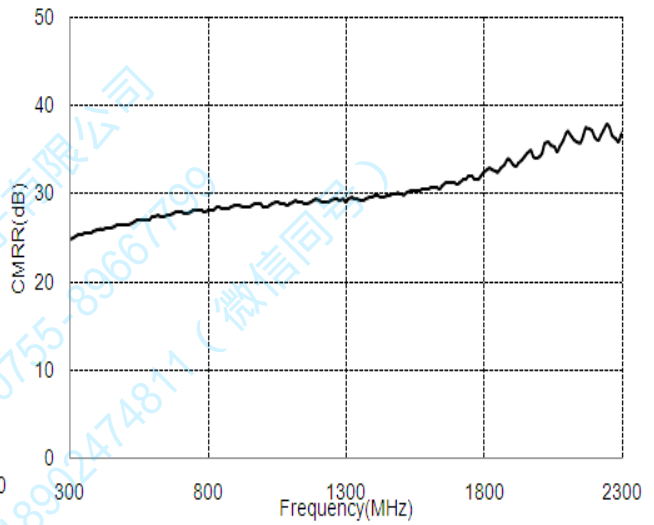

BW21C2511A01TF

Insertion Loss vs. Frequency

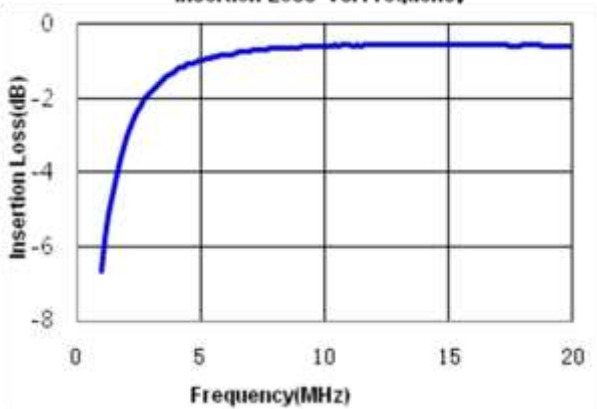

CMRR vs. Frequency

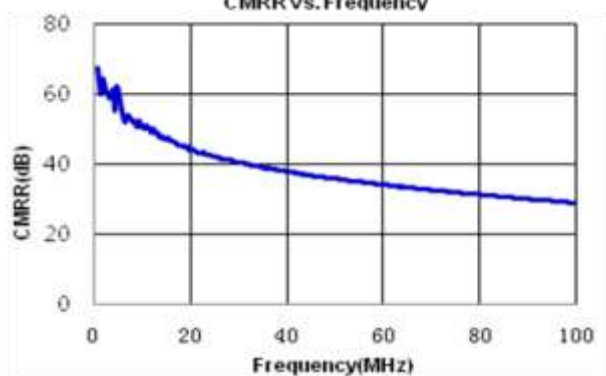

TYPICAL ELECTRICAL CHARACTERISTICS

BW21C2511A01TF

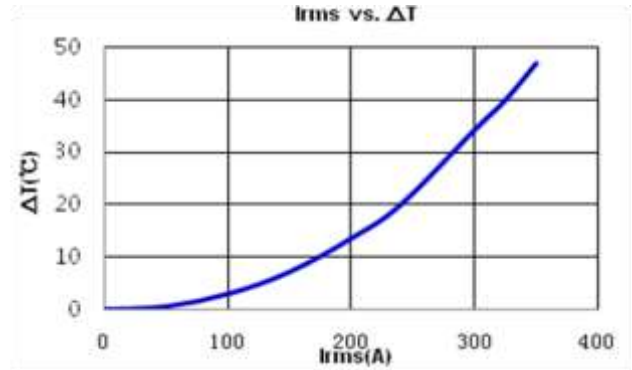
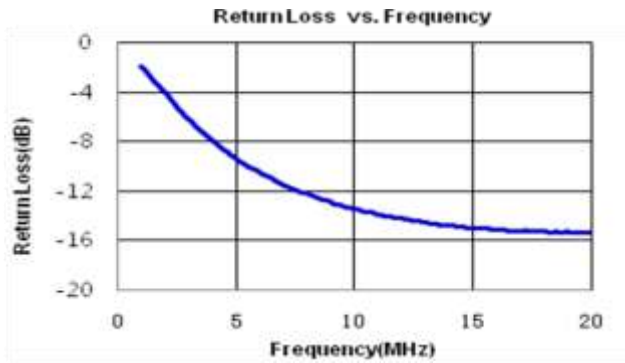

BW43S5011C01TF/BW43S5011E01TF

Insertion Loss Characteristics

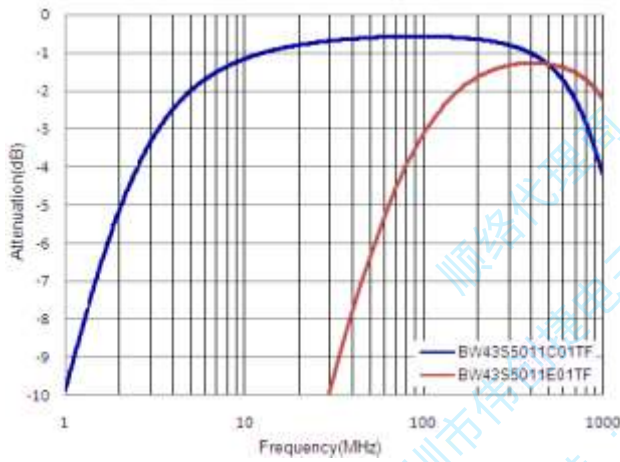

深圳市伟拓电子有限公司
技术支持: 0755-89667799
手机: 18902474811 (微信同号)