

Assembled SMD Power Inductors – WPZ Series

Operating Temp. : -40°C~+125°C(Including self-heating)



FEATURES

- High saturation characteristic core for large saturation current and low loss
- Closed magnetic circuit design reduces leakage flux
- High precision DCR
- Halogen free, RoHS compliant

APPLICATIONS

- Server, desktop computer, notebook
- Graphics, memory
- Industrial equipment, telecom base station

PRODUCT IDENTIFICATION

<u>WPZ</u> ①	<u>1008</u> ②	<u>7</u> ③	<u>S</u> ④	<u>1</u> ⑤	<u>R12</u> ⑥	<u>K</u> ⑦	<u>T</u> ⑧
① Type	② External Dimensions(L×W) [mm]		③ External Height Dimensions(H) [mm]		⑤ Number of Windings		⑥ Nominal Inductance
WPZ SMD Power Inductor	0404 4.0×4.1	0505 5.2×5.2	1 H<1.5	1 1 Winding	Example Nominal Value		
	0606 6.4×6.4	0707 7.0×7.3	2 1.5≤H<2.5	2 2 Windings	70N 70nH	⑦ Inductance Tolerance	⑧ Packing
	0905 9.0×5.0	0906 9.6×6.4	3 2.5≤H<3.5		R12 120nH		
	0907 9.5×7.5	1006 10.0×6.15	4 3.5≤H<4.5			K ±10%	T Tape & Reel
	1007 10.7×7.0	1008 10.4×8.0	5 4.5≤H<5.5			L ±15%	
	1010 10.0×10.0	1106 10.6×6.3	6 5.5≤H<6.5			M ±20%	
	1107 11.0×7.4	1107 11.0×7.4	7 6.5≤H<7.5				
	1111 11.2×11.2	1111 11.2×11.2	8 7.5≤H<8.5				
	1205 12.0×5.0	1205 12.0×5.0	9 8.5≤H<9.5				
	1206 12.0×6.0	1206 12.0×6.0	A 9.5≤H<10.5				
	1308 13.5×8.5	1308 13.5×8.5	B 10.5≤H<11.5				
	1313 13.7×12.8	1313 13.7×12.8	C 11.5≤H<12.5				
	1612 15.3×11.3	1612 15.3×11.3	D 12.5≤H<13.5				
	1811 18.0×11.3	1811 18.0×11.3	E 13.5≤H<14.5				
			F 14.5≤H<15.5				
			G 15.5≤H<16.5				
			④ Magnetic Core Material				
			B High Saturation				
			S Low Loss				
			F High Frequency				
			N NiZn				
			M Alloy				

SHAPE AND DIMENSIONS — 2 Pins

Fig.1

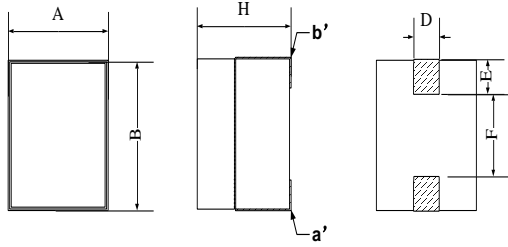

Fig.2

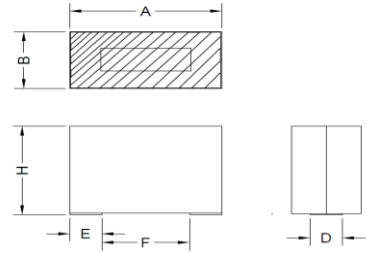

Fig.3

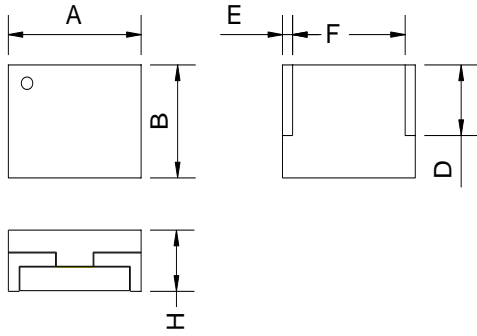

Fig.4

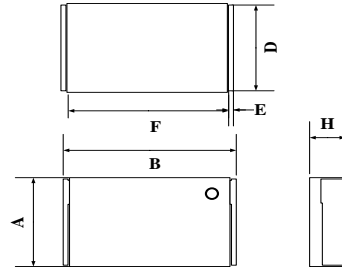

Fig.5

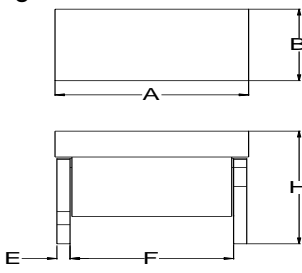

Fig.6

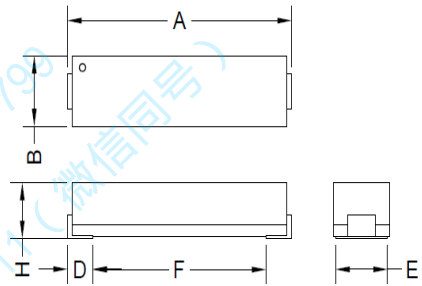
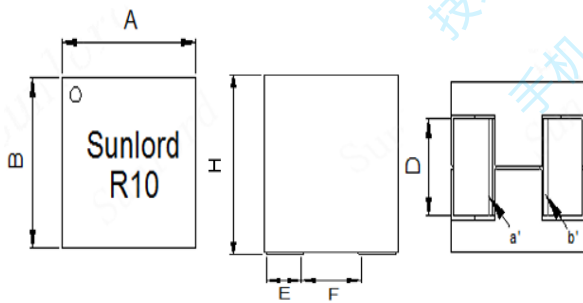
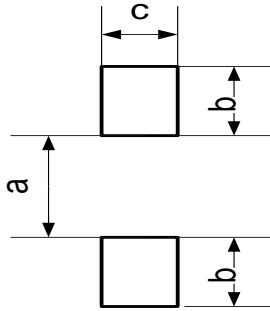

Fig.7



SHAPE AND DIMENSIONS — 2 Pins

Recommended Land Pattern (Typ.)



Unit: mm

Series	Shape	A Max.	B Max.	H Max.	D	E	F	a Typ.	b Typ.	c Typ.
WPZ04044S1	Fig.1	4.0	4.1	4.0/4.3	1.0±0.2	1.2±0.3	/	0.7	1.8	1.4
WPZ05057S1	Fig.1	5.2	5.2	6.5	2.0±0.2	0.7±0.2	3.7±0.3	3.2	1.15	2.5
WPZ0606AF1	Fig.7	6.5	6.5	10	3.7±0.2	1.75±0.2	2.65±0.2	2.05	2.35	4.1
WPZ07074N1	Fig.1	6.8	7.3	4.2	1.0±0.2	1.9±0.4	3.2±1.0	2.6	2.5	1.4
WPZ07074S1	Fig.1	6.8	7.3	3.8	3.0±0.2	1.6±0.3	3.8 Typ.	3.2	2.2	3.4
WPZ07075S1	Fig.1	7.0	7.0	5.0	2.5±0.25	1.5±0.3	3.9 Typ.	3.3	2.1	3.0
WPZ0707BB1	Fig.7	7.0	6.9/6.7	11	3.7±0.2	1.8±0.2	2.8±0.3	2.3	2.3	4.2
WPZ09068S1	Fig.2	9.6	6.4	8.1	2.5±0.2	2.14±0.2	4.2 Typ.	3.6	3.1	2.54
WPZ09059F1	Fig.2	9.0	5.2/5.0	9.5	2.4±0.2	2.5±0.2	/	3.4	3.1	2.8
WPZ0906AB1	Fig.2	9.6	6.6/6.4	10.1	3.15±0.2	2.8±0.2	3.8 Typ.	3.4	3.3	3.6
WPZ0906AS1	Fig.2	9.6	6.6/6.4	10.1	3.15±0.2	2.8±0.2	3.8 Typ.	3.4	3.3	3.6
WPZ0906AF1	Fig.2	9.6	6.6/6.4	10.1	2.6±0.2	2.8±0.2	3.8 Typ.	3.4	3.3	3.6
WPZ09074S1	Fig.3	9.5	7.5	4.0	4.5±0.2	0.65±0.2	7.7 Typ.	7.1	1.25	4.9
WPZ09075S1	Fig.1	7.0	9.6	5.5	2.3±0.1	2.3±0.3	4.8±0.3	4.2	2.9	2.7
WPZ09079S1	Fig.3	9.5	7.5	9.0	4.3 Typ.	1.2 Typ.	6.2 Typ.	5.8	1.8	4.7
WPZ1006CB1	Fig.2	10.0	6.0	12.0	2.45±0.3	2.95±0.3	3.65±0.5	3.05	3.55	2.85
WPZ1006CS1	Fig.2	10.0	6.15/6.0	12.0	2.45±0.3	2.95±0.3	3.65±0.5	3.05	3.55	2.85
WPZ10075B1	Fig.1	7.0	10.2	5.0	2.5±0.1	1.9±0.2	6.0 Typ.	5.4	2.5	3.0
WPZ10075S1	Fig.1	7.0	10.25	5.2	2.54±0.1	2.03±0.2	5.94±0.2	5.08	2.8	3.05
WPZ10075M1	Fig.1	7.0	10.7	5.0	2.54±0.2	2.3±0.2	5.9 Typ.	5.3	2.9	2.94
WPZ1007AS1	Fig.2	10.0	7.0	10.0	2.2±0.25	2.5±0.3	4.1±0.3	3.5	3.1	2.6
WPZ1007CS1	Fig.7	10.7	7.9/7.7/7.5	12	3.1±0.2	2.8±0.3	4.4±0.3	3.7	3.4	3.5
WPZ10087S1	Fig.1	8.0	10.3	7.0	2.3±0.2	3.0±0.2	4.0 Typ.	3.4	3.6	2.7
WPZ10087B1	Fig.1	8.0	10.4	7.5	2.25±0.2	2.54±0.2	5.12 Typ.	4.7	3.0	2.5
WPZ10088S1	Fig.1	8.0	10.4	8.2/8.0	2.1±0.1	2.54±0.2	4.86 Typ.	4.26	3.14	2.5
WPZ11068S1	Fig.5	10.6	6.3	8.1	5.0±0.2	0.7±0.1	8.7 Min.	8.4	1.3	5.6/3.0
WPZ11077S1	Fig.1	7.4	11.0	7.7	1.9±0.3	2.6±0.3	5.5 Typ.	4.9	3.2	2.3
WPZ11119S1	Fig.1	11.2	11.2	9.0	2.1±0.3	2.6±0.3	/	5.3	3.1	2.54
WPZ13083S1	Fig.4	8.55	13.55	3.0	8.15±0.2	0.50±0.1	12.85±0.2	11.75	1.1	8.7
WPZ13138S1	Fig.1	12.8	13.7	8.1	6.5 Typ.	2.7 Typ.	7.8 Typ.	7.2	3.2	6.9

SPECIFICATIONS

Part Number	Inductance	L Test Condition	DC Resistance	Saturation Current		Heat Rating Current	
Units	nH	/	mΩ	Isat A		A	
Symbol	L	/	DCR	25°C	100°C	Irms	
WPZ04044S122NMT	22±20%	@100kHz, 1V	0.30±10%	40	34	48	
WPZ04044S150NKT	50±10%			35	30		
WPZ04044S165NKT	65±10%			30	23		
WPZ04044S1R10KT	100±10%			17	15		
WPZ05057S160NMT	55±20%	@100kHz, 1V	0.25±20%	70	60	50	
WPZ05057S180NMT	80±20%			50	40		
WPZ05057S1R10MT	100±20%			40	30		
WPZ05057S1R11MT	110±20%			36	27		
WPZ05057S1R15MT	150±20%			25	20		
WPZ0606AF170NKT	70±10%	@800kHz, 0.1V	0.17±10%	120	100	70	
WPZ0606AF1R10KT	100±10%			85	70		
WPZ0606AF1R12KT	120±10%			70	60		
WPZ0606AF1R15KT	150±10%			56	46		
WPZ07074N1R10MT	100±20%	@100kHz, 1V	0.5 Max.	20	/	15	
WPZ07074S160NMT	60±20%		0.19 Max.	51	/	30	
WPZ07074S1R10MT	100±20%			34	/		
WPZ07075S160NMT	60±20%		0.32±9.4%	70	54	37	
WPZ07075S170NMT	72±20%			58	45		
WPZ07075S1R10MT	105±20%			46	38		
WPZ07075S1R15MT	150±20%			34	24		
WPZ0707BB155NLT	55±15%		@100kHz, 1V	0.145±10%	155	130	76
WPZ0707BB170NKT	70±10%				134	114	
WPZ0707BB1R10KT	100±10%				93	79	
WPZ0707BB1R12KT	120±10%				76	65	
WPZ0707BB1R15KT	150±10%				60	51	
WPZ0707BB1R22KT	220±10%	42			35		
WPZ0707BB1R33KT	330±10%		28	22			
WPZ09068S1R10KT	100±10%	@100kHz, 0.1V	0.29±5%	94	81	51	
WPZ09068S1R12KT	120±10%			79	68		
WPZ09068S1R15KT	150±10%			65	55		
WPZ09068S1R18KT	180±10%			55	45		
WPZ09068S1R22KT	220±10%			44	37.5		
WPZ09068S1R28KT	280±10%			34	29		
WPZ09068S1R30KT	300±10%		32.5	27.5			
WPZ09059F190NKT	90±10%	@500kHz, 0.1V	0.125±10%	90	77	63	
WPZ09059F1R10KT	100±10%			80	70		
WPZ09059F1R12KT	120±10%			72	64		
WPZ09059F1R15KT	150±10%			58	51		
WPZ09059F1R18KT	180±10%			49	42		
WPZ09059F1R21KT	210±10%			38	33		
WPZ09059F1R24KT	240±10%			33	30		
WPZ09059F1R27KT	270±10%			30	26		
WPZ09059F1R33KT	330±10%		23	19			
WPZ0906AB170NKT	70±10%	@800kHz, 0.1V	0.12 Max. (0.10 Typ.)	145	126	84	
WPZ0906AB1R10KT	100±10%			110	90		
WPZ0906AB1R12KT	120±10%			90	75		
WPZ0906AB1R15KT	150±10%			67	58		
WPZ0906AB1R18KT	180±10%			56	49		
WPZ0906AB1R22KT	220±10%			46	40		
WPZ0906AB1R28KT	280±10%		36	31			

SPECIFICATIONS

Part Number	Inductance	L Test Condition	DC Resistance	Saturation Current		Heat Rating Current
Units	nH	/	mΩ	Isat A		A
Symbol	L	/	DCR	25°C	100°C	Irms
WPZ0906AS170NKT	70±10%	@100kHz, 0.1V	0.12 Max. (0.10 Typ.)	120	104	84
WPZ0906AS1R10KT	100±10%			93	74	
WPZ0906AS1R12KT	120±10%			70	60	
WPZ0906AS1R15KT	150±10%			55	48	
WPZ0906AS1R18KT	180±10%			46	40	
WPZ0906AS1R22KT	220±10%			38	33	
WPZ0906AS1R28KT	280±10%			30	26	
WPZ0906AF170NKT	70±10%			120	104	
WPZ0906AF1R10KT	100±10%			93	74	
WPZ0906AF1R12KT	120±10%			70	60	
WPZ0906AF1R15KT	150±10%			55	48	
WPZ0906AF1R18KT	180±10%			46	40	
WPZ0906AF1R22KT	220±10%			38	33	
WPZ0906AF1R28KT	280±10%			30	26	
WPZ09074S170NLT	70±15%	@800kHz, 0.1V	0.32±10%	78	/	39
WPZ09074S1R10LT	100±15%			55	/	
WPZ09074S1R14LT	140±15%			39	/	
WPZ09074S1R15LT	150±15%			33	/	
WPZ09074S1R18LT	175±15%			28	/	
WPZ09075S170NLT	70±15%	@100kHz, 1V	0.14±10%	100	85	65 Min
WPZ09075S1R10LT	100±15%			70	59	
WPZ09075S1R12LT	120±15%			58	49	
WPZ09075S1R15LT	150±15%			46	39	
WPZ09075S1R18LT	180±15%			38	33	
WPZ09075S1R22LT	220±15%			31	27	
WPZ09079S1R10LT	100±15%	@800kHz, 1V	0.20 Max. (0.17 Typ.)	80	/	50
WPZ09079S1R12LT	120±15%			66	/	
WPZ09079S1R15LT	150±15%			53	/	
WPZ09079S1R18LT	180±15%			44	/	
WPZ09079S1R22LT	220±15%			36	/	
WPZ09079S1R28LT	280±15%			28	/	
WPZ09079S1R30LT	300±15%			26	/	
WPZ1006CB170NLT	70±15%	@100kHz, 1V	0.125±10%	175	150	70
WPZ1006CB180NLT	80±15%			155	130	
WPZ1006CB1R10LT	100±15%			125	105	
WPZ1006CB1R12LT	120±15%			105	88	
WPZ1006CB1R14LT	135±15%			92	77	
WPZ1006CB1R15LT	150±15%			83	70	
WPZ1006CB1R22LT	220±15%			52	42	
WPZ1006CB1R25LT	250±15%			46	36	
WPZ1006CB1R33LT	330±15%			35	28	
WPZ1006CS170NLT	70±15%			152	130	
WPZ1006CS180NLT	80±15%			134	113	
WPZ1006CS1R10LT	100±15%			108	92	
WPZ1006CS1R12LT	120±15%			91	76	
WPZ1006CS1R14LT	135±15%			80	67	
WPZ1006CS1R15LT	150±15%			72	60	
WPZ1006CS1R22LT	220±15%			45	36	
WPZ1006CS1R25LT	250±15%			40	31	
WPZ1006CS1R33LT	330±15%	30	24			

SPECIFICATIONS

Part Number	Inductance	L Test Condition	DC Resistance	Saturation Current		Heat Rating Current
Units	nH	/	mΩ	Isat A		A
Symbol	L	/	DCR	25°C	100°C	Irms
WPZ10075B1R12KT	120±10%	@100kHz, 1V	0.35±10%	61	/	31
WPZ10075B1R15KT	150±10%			49	/	
WPZ10075B1R20KT	200±10%			37	/	
WPZ10075B1R22KT	220±10%			32	/	
WPZ10075B1R30KT	300±10%			21	/	
WPZ10075S170NKT	70±10%		0.1375 Max.	85	78	40
WPZ10075S1R10KT	100±10%			60	55	
WPZ10075S1R12KT	120±10%			50	45	
WPZ10075S1R15KT	150±10%			40	36	
WPZ10075S1R20KT	200±10%			30	27	
WPZ10075S1R30KT	300±10%		19	17		
WPZ10075M170NLT	70±15%		0.23±10%	130	/	68
WPZ10075M1R10LT	100±15%			96	/	
WPZ10075M1R12LT	120±15%			80	/	
WPZ10075M1R16LT	160±15%			60	/	
WPZ1007AS170NLT	70±15%		0.17±10%	165	120	68
WPZ1007AS1R10LT	100±15%			135	100	
WPZ1007AS1R12LT	120±15%			107	80	
WPZ1007AS1R15LT	150±15%			92	75	
WPZ1007AS1R20LT	200±15%			68	51	
WPZ1007AS1R22LT	220±15%			62	47	
WPZ1007AS1R33LT	330±15%			37	28	
WPZ1007CS170NKT	70±10%		0.150±10%	194	181	75
WPZ1007CS1R10KT	100±10%			136	126	
WPZ1007CS1R12KT	120±10%			113	105	
WPZ1007CS1R15KT	150±10%			90	84	
WPZ1007CS1R18KT	180±10%			75	70	
WPZ1007CS1R20KT	200±10%			67	62	
WPZ1007CS1R22KT	220±10%			61	57	
WPZ1007CS1R27KT	270±10%			51	47	
WPZ1007CS1R33KT	330±10%			41	38	
WPZ1007CS1R47KT	470±10%			29	27	
WPZ10087S1R10KT	100±10%		0.29±10%	96	/	72
WPZ10087S1R12KT	120±10%			80	/	60
WPZ10087S1R15KT	150±10%			72	/	
WPZ10087S1R17KT	170±10%			58	/	
WPZ10087S1R20KT	200±10%			48	/	
WPZ10087S1R22KT	220±10%			46	/	
WPZ10087S1R30KT	300±10%			32	/	
WPZ10087S1R33KT	330±10%		28	/		
WPZ10087B1R10KT	100±10%	0.29±5%	108	98	61	
WPZ10087B1R12KT	115±10%		94	86		
WPZ10087B1R15KT	150±10%		76	70		
WPZ10087B1R17KT	175±10%		66	60		
WPZ10087B1R20KT	200±10%		57	52		
WPZ10087B1R22KT	215±10%		50	43		
WPZ10087B1R23KT	230±10%		48	40		
WPZ10087B1R27KT	270±10%		40	34		
WPZ10087B1R30KT	300±10%	35	30			

SPECIFICATIONS

Part Number	Inductance	L Test Condition	DC Resistance	Saturation Current		Heat Rating Current
Units 单位	nH	/	mΩ	Isat A		A
Symbol 符号	L	/	DCR	25°C	100°C	Irms
WPZ10088S180NKT	80±10%	@100kHz, 0.1V	0.18±5%	130	120	68
WPZ10088S182NKT	82±10%			126	116	
WPZ10088S1R10KT	100±10%			113	100	
WPZ10088S1R12KT	120±10%			95	84	
WPZ10088S1R15KT	150±10%			78	69	
WPZ10088S1R18KT	180±10%			62	56	
WPZ10088S1R22KT	220±10%			52	45	
WPZ10088S1R27KT	270±10%			41	36	
WPZ10088S1R30KT	300±10%			35	33	
WPZ10088S1R33KT	330±10%			33	30	
WPZ11068S1R10KT	100±10%			@300kHz, 0.1V	0.35 Max.	
WPZ11068S1R12KT	120±10%	78	67			
WPZ11068S1R16KT	160±10%	60	50			
WPZ11068S1R20KT	200±10%	45	38			
WPZ11077S170NKT	70±10%	@100kHz, 1V	0.29±10%	150	140	39
WPZ11077S1R12KT	120±10%			95	83	
WPZ11077S1R15KT	150±10%			80	62	
WPZ11077S1R17KT	170±10%			70	55	
WPZ11077S1R20KT	200±10%			60	45	
WPZ11077S1R23KT	230±10%			50	36	
WPZ11077S1R30KT	300±10%			37	28	
WPZ11077S1R40KT	400±10%			25	18	
WPZ11077S1R50KT	500±10%			18	13	
WPZ11077S1R51KT	510±10%			18	13	
WPZ11119S150NMT	50±20%	@100kHz, 1V	0.42±10%	180	/	35
WPZ11119S1R10MT	100±20%			145	/	
WPZ11119S1R12MT	120±20%			120	/	
WPZ11119S1R15MT	150±20%			100	/	
WPZ11119S1R20MT	200±20%			80	/	
WPZ11119S1R25MT	250±20%			63	/	
WPZ11119S1R27MT	270±20%			58	/	
WPZ11119S1R30MT	300±20%			53	/	
WPZ11119S1R47MT	470±20%			36	/	
WPZ11119S1R56MT	560±20%			30	/	
WPZ11119S1R0MT	1000±20%			15	/	
WPZ13083S1R11KT	110±10%	@100kHz, 0.1V	0.45±10%	65	/	30
WPZ13083S1R15KT	145±10%			50	/	
WPZ13083S1R21KT	210±10%			34	/	
WPZ13083S1R26KT	260±10%			27	/	
WPZ13083S1R32KT	320±10%			22	/	
WPZ13138S1R11KT	110±10%	@100kHz, 1V	0.19±10%	140	113	68
WPZ13138S1R15KT	150±10%			100	80	
WPZ13138S1R18KT	180±10%			85	68	
WPZ13138S1R21KT	210±10%			80	64	
WPZ13138S1R26KT	260±10%			61	50	
WPZ13138S1R32KT	320±10%			45	36	
WPZ13138S1R36KT	360±10%			40	32	
WPZ13138S1R44KT	440±10%			37	30	
WPZ13138S1R50KT	500±10%			28	22	

※1: All test data is referenced to 25°C ambient;

※2: Isat: DC current at which the inductance drops approximate 20% from its value without current;

※3: Irms: DC current that causes the temperature rise (ΔT) from 25°C ambient when two coils connected in series, ΔT is approximate 40°C.

SHAPE AND DIMENSIONS — 3 Pins

Fig.1

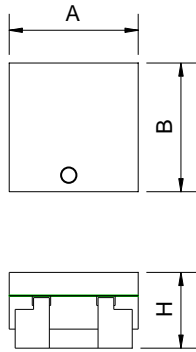

Fig.2

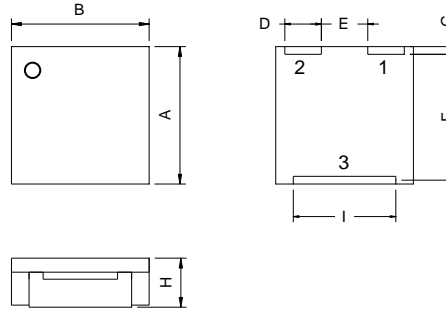
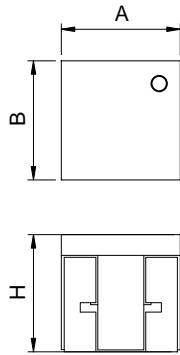

Fig.3



Recommended Land Pattern (Typ.)



Fig.4

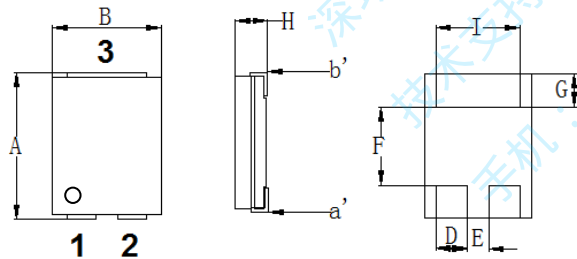

Recommended Land Pattern (Typ.)

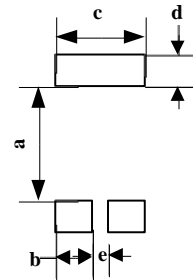

Unit: mm

Series	Shape	A	B	H	D	E	F	G	I	a	b	c	d	e
		Max.	Max.	Max.	Max.	Max.	Max.	Max.	Max.	Typ.	Typ.	Typ.	Typ.	Typ.
WPZ06065S1	Fig.3	6.4	6.4	5.3	1.82	2.9	5.5	0.55	3.7	4.7	2.2	3.9	1.0	2.1
WPZ10103S1	Fig.2	10.0	10.0	3.35	2.8	3.3	8.9	0.6	7.6	8.0	3.2	7.8	1.25	2.6
WPZ10106S1	Fig.1	10.0	10.0	6.0	2.7	4.0	8.6	0.7	6.2	8.0	3.0	6.5	1.2	3.3
WPZ16123S1	Fig.4	15.3	11.3	3.0	3.2	2.65	10.3	2.7	8.65	8.6	4.0	9.5	3.9	1.5
WPZ18113S1	Fig.4	18.0	11.4	3.0	/	/	/	/	/	11.6	3.7	9.0	3.2	/

EQUIVALENT CIRCUIT

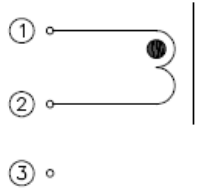

SPECIFICATIONS

Part Number	Inductance (pin1-2)	L Test Condition	DC Resistance (pin1-2)	Saturation Current (pin1-2)			Heat Rating Current (pin1-2)	
				25°C	100°C	125°C		
Units	nH	/	mΩ	Isat A			A	
Symbol	L	/	DCR	25°C	100°C	125°C	I _{rms}	
WPZ06065S1R10KT	100±10%	@1MHz, 1V	0.4±12.5%	50	40	/	24	
WPZ06065S1R12KT	120±10%			41	33	/		
WPZ06065S1R15KT	150±10%			33	26	/		
WPZ06065S1R20KT	200±10%			25	20	/		
WPZ10103S1R10LT	100±15%		0.45±15%	79	/	61	31	
WPZ10103S1R15LT	150±15%			52	/	41		
WPZ10103S1R22LT	220±15%			36	/	28		
WPZ10103S1R30LT	300±15%			26	/	20		
WPZ10106S1R10KT	100±10%		0.66±10%	120	/	95	20	
WPZ10106S1R20KT	200±10%			60	/	50		
WPZ10106S1R22KT	220±10%			54	/	43		
WPZ10106S1R30KT	300±10%			43	/	33		
WPZ10106S1R45KT	450±10%			29	/	23		
WPZ10106S1R50KT	500±10%			26	/	20		
WPZ16123S1R16KT	145~185		@300KHz, 1V	0.66 Max.	55	45	/	28.5
WPZ18113S1R25KT	250±10%				30	/	/	25

SHAPE AND DIMENSIONS — 4 Pins

Fig.1

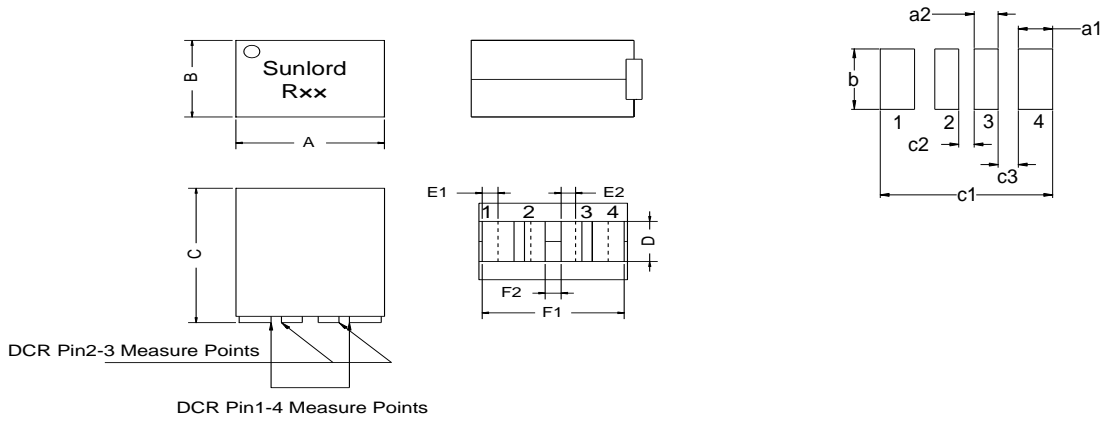
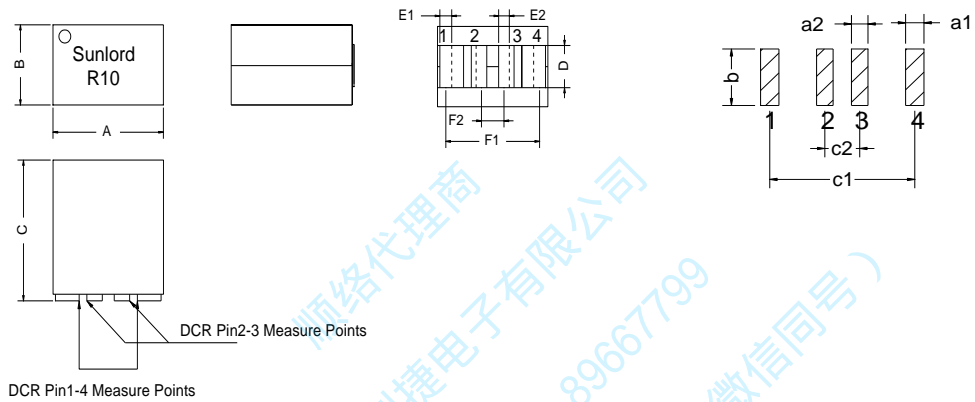

Fig.2



Unit: mm

Series	Shape	A	B	C	D	E1	E2	F1	F2	a1	a2	b	c1	c2	c3
		Max.	Max.	Max.	Max.	Max.	Max.	Max.	Max.	Typ.	Typ.	Typ.	Typ.	Typ.	Typ.
WPZ0906AS2	Fig.1	9.6	6.4	10	3.4	1.8	1.3	9.75	1.9	2.15	1.45	3.6	10.1	1.0	3.1
WPZ0906BS2	Fig.1	9.6	6.4	11.4	3.25	1.65	1.06	9.55	1.78	1.85	1.26	3.55	9.75	0.98	1.275
WPZ1205CS2	Fig.1	12.0	5.0/5.1	12.0	2.2	1.85	1.55	11.99	1.4	2.15	1.6	2.4	12.25	0.8	/
WPZ1206BS2	Fig.2	12.0	6.0	11.1	2.75	1.6	1.45	10.6	3.15	1.8	1.65	2.85	10.1	2.65	/
WPZ1206CS2	Fig.1	12.0	6.0/6.1	12.1	2.9	1.93	1.57	11.76	1.65	2.13	1.77	3.05	12.2	0.85	/

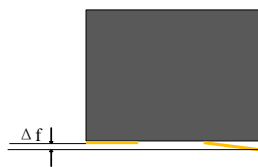

Fig.4

Δf : Clearance between terminal and the surface of plate must be 0.1mm Max. when coil is placed on a flat plate. (Refer to Fig.4)

SPECIFICATIONS

Part Number	Inductance	L Test Condition	DC Resistance		Saturation Current		Heat Rating Current		Hi-Pot	Lk
					(Pin1-4) A		A			@25°C
Units	nH	/	mΩ		Isat (Pin1-4) A		A		/	/
Symbol	L(Pin1-4)	/	Pin1-4	Pin2-3	25°C	100°C	Irms (Pin1-4)	Irms (Pin2-3)	Pri(1.4)-Sec(2.3)	Pin1-4 (Shorted Pin2-3)
WPZ0906AS2R10LT	100±15%	@500KHz, 0.25V	0.125±10%	0.45±10%	92	82	75	39	100Vdc 2s 2mA	/
WPZ0906AS2R12LT	120±15%				75	66				
WPZ0906AS2R15LT	150±15%				60	52				
WPZ0906BS270NLT	70±15%	@100KHz, 0.1V	0.125±10%	0.60±10%	149	129	75	/		
WPZ0906BS280NLT	80±15%				131	113				
WPZ0906BS2R10LT	100±15%				105	91				
WPZ0906BS2R11LT	110±15%				95	82				
WPZ0906BS2R12LT	120±15%				87	75				
WPZ0906BS2R15LT	150±15%				70	60				
WPZ0906BS2R17LT	170±15%				61	53				
WPZ1205CS270NLT	70±15%	@100KHz, 1V	0.125±10%	0.45±10%	145	126	75	39	10nH Max.	
WPZ1205CS2R10LT	100±15%				102	90				
WPZ1205CS2R12LT	120±15%				85	74				
WPZ1205CS2R15LT	150±15%				68	59				
WPZ1205CS2R17LT	170±15%				57	50				
WPZ1206BS270NLT	70±15%	@100KHz, 1V	0.143Max. (0.13Typ.)	0.429Max. (0.39Typ.)	157	142	78	45	200Vdc 2s 2mA	20%*L Max.
WPZ1206BS2R10LT	100±15%				112	100				
WPZ1206BS2R12LT	120±15%				94	83				
WPZ1206BS2R15LT	150±15%				74	66				
WPZ1206BS2R17LT	170±15%				64	58				
WPZ1206BS2R20LT	200±15%	55	50							
WPZ1206CS270NLT	70±15%	@100KHz, 1V	0.125±10%	0.37±10%	178	145	75	40	100Vdc 2s 2mA	10nH Max.
WPZ1206CS2R10LT	100±15%				125	100				
WPZ1206CS2R12LT	120±15%				106	88				
WPZ1206CS2R15LT	150±15%				82	70				
WPZ1206CS2R17LT	170±15%				73	60				

※1: All test data is referenced to 25°C ambient;

※2: Isat: DC current at which the inductance drops approximate 20% from its value without current;

※3: Irms: DC current that causes the temperature rise (ΔT) from 25°C ambient when two coils connected in series, ΔT is approximate 40°C.

TYPICAL ELECTRICAL CHARACTERISTICS

WPZ04044S1 Series

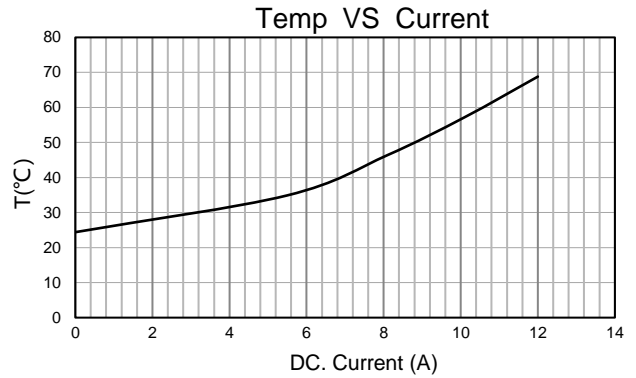
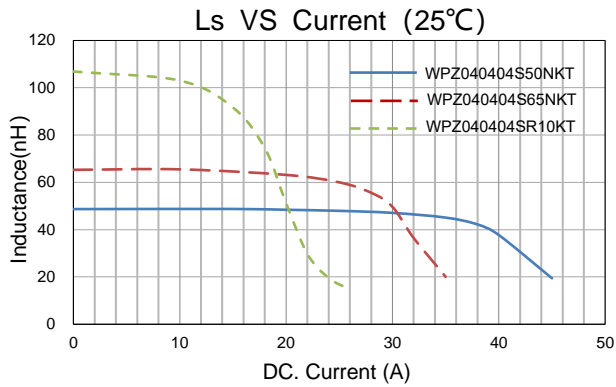

WPZ05057S1 Series

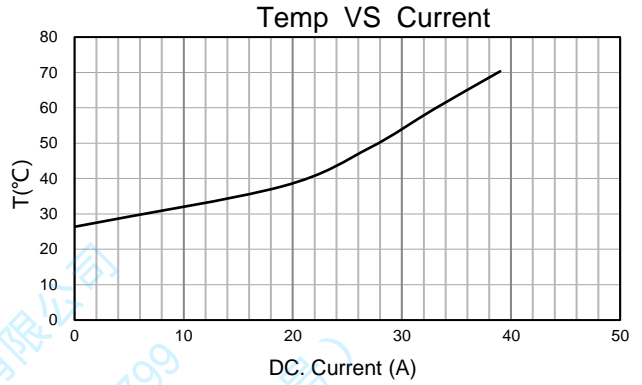
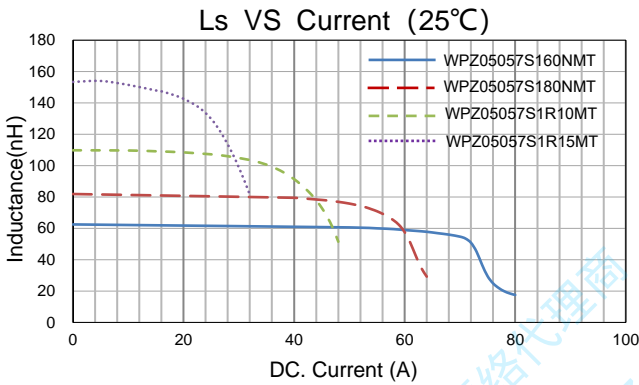

WPZ0606AF1 Series

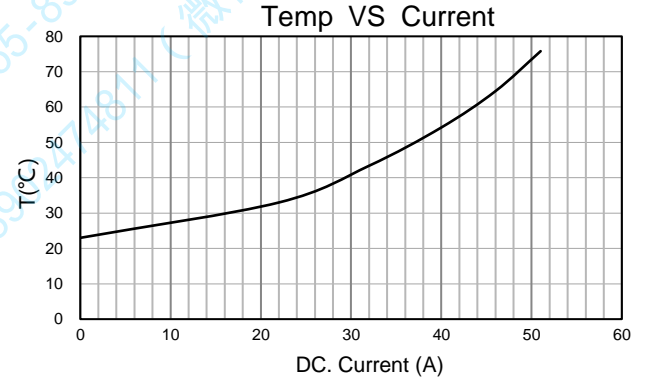
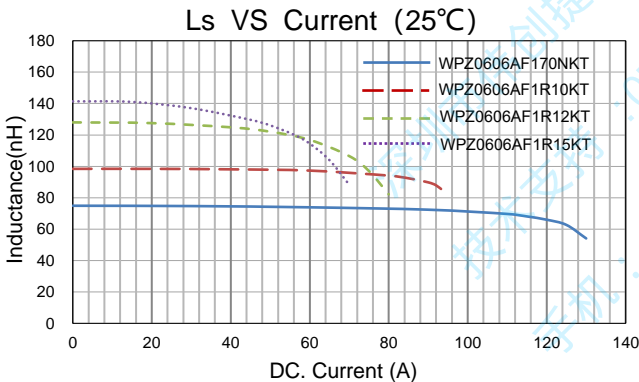

WPZ07074N1 Series

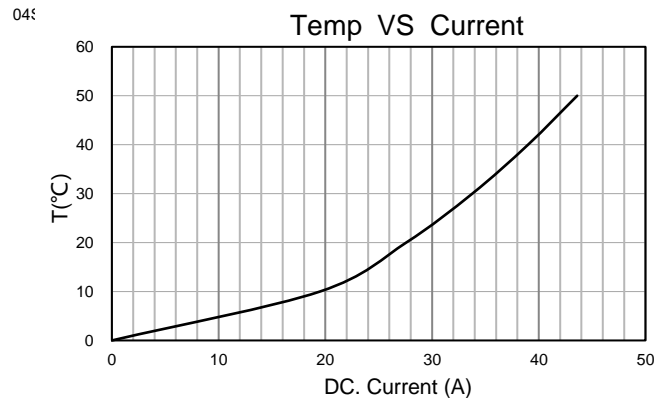
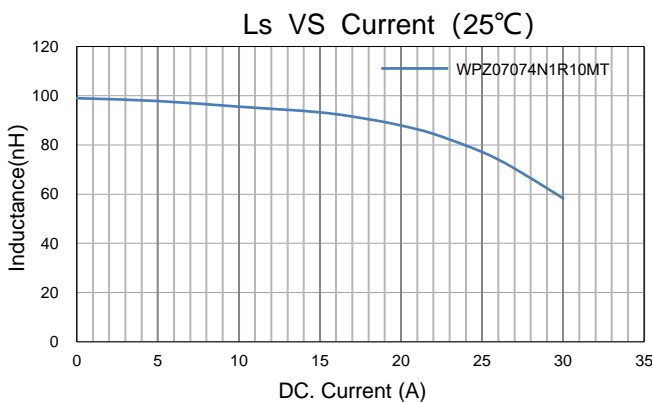

TYPICAL ELECTRICAL CHARACTERISTICS

WPZ07074S1 Series

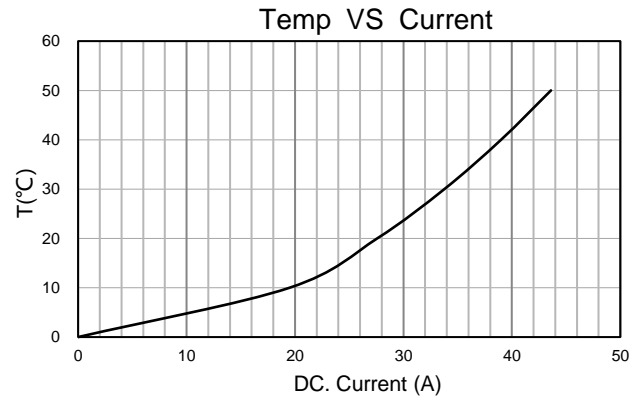
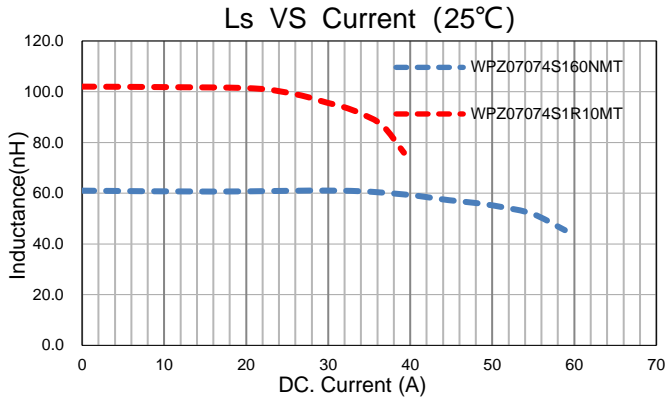

WPZ07075S1 Series

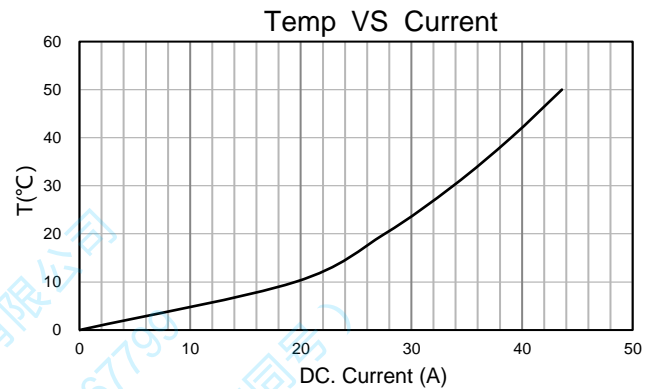
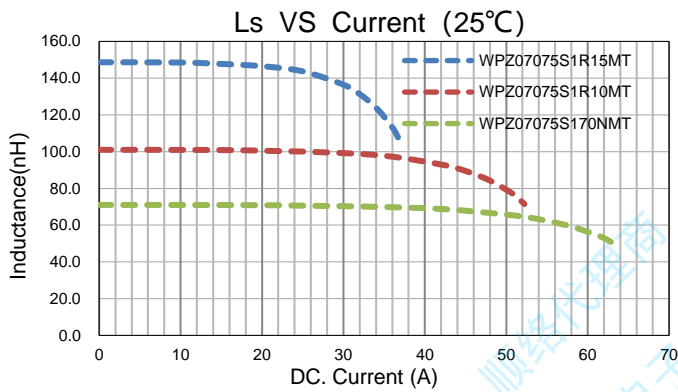

WPZ0707BB1 Series

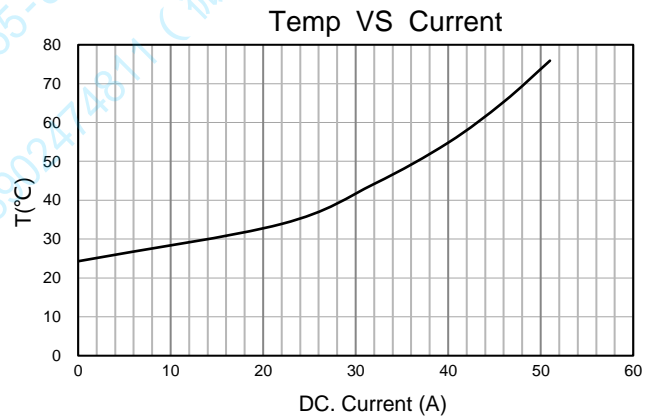
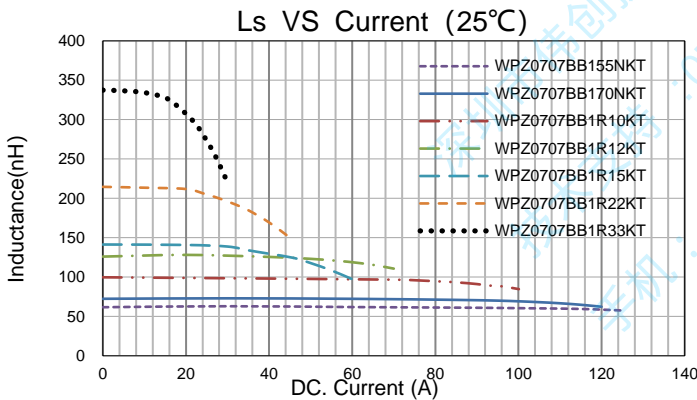

WPZ09068S1 Series

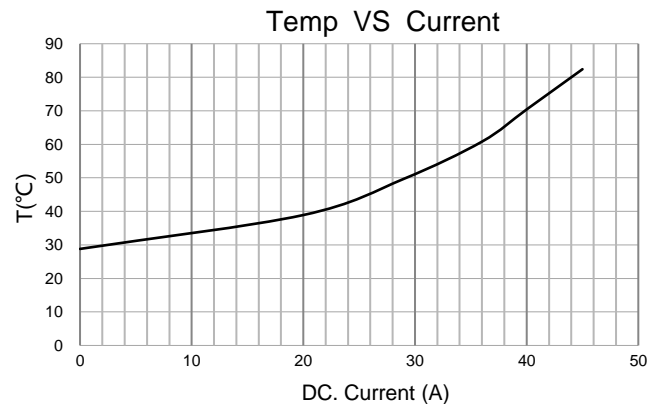
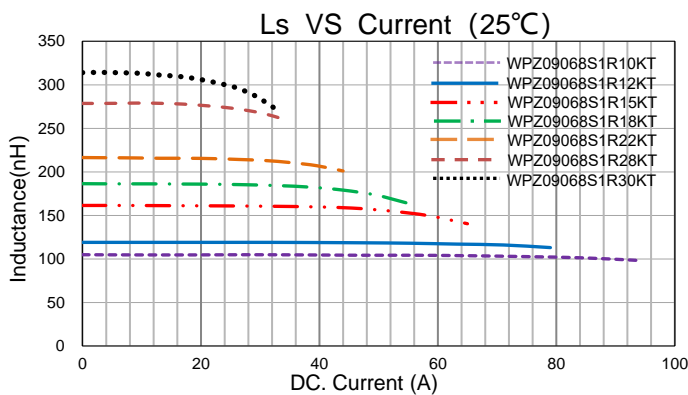

TYPICAL ELECTRICAL CHARACTERISTICS

WPZ09059F1 Series

Ls VS Current (25°C)

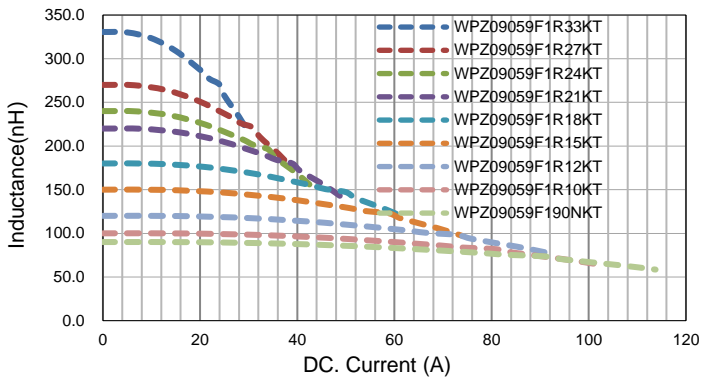

Temp VS Current

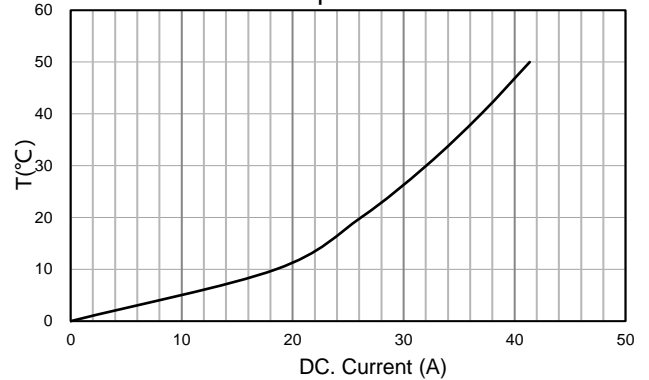

WPZ0906AB1 Series

Ls VS Current (25°C)

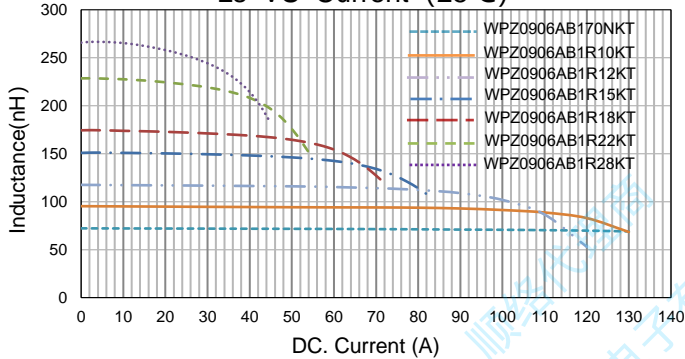

Temp VS Current

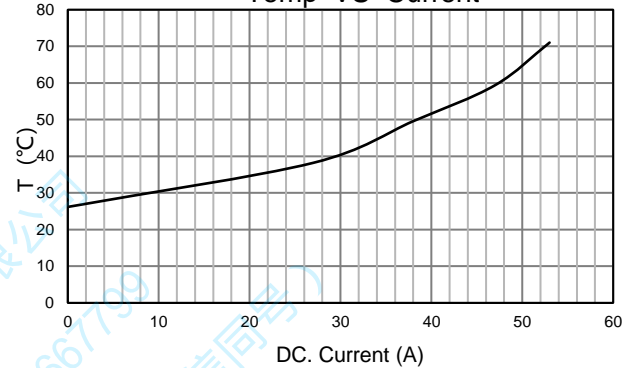

WPZ0906AS1 Series

Ls VS Current (25°C)

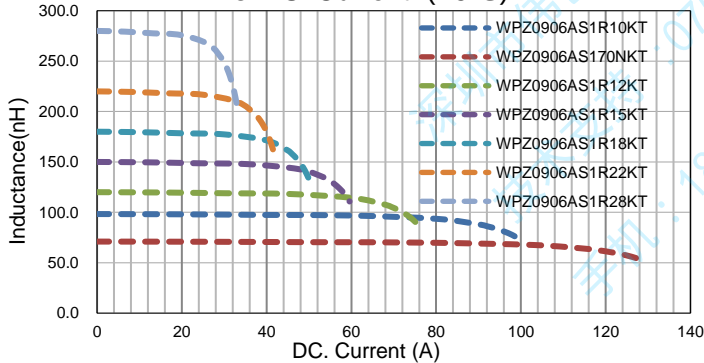

Temp VS Current

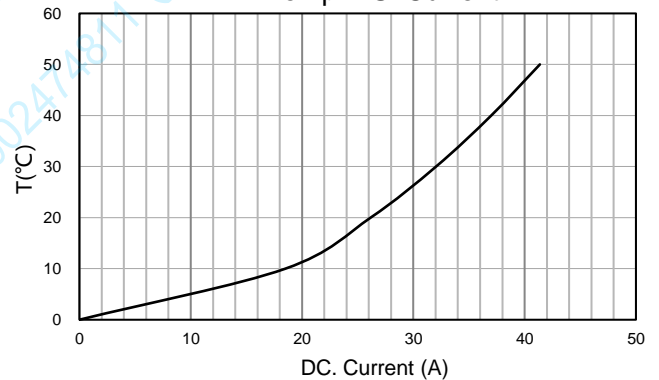

WPZ0906AF1 Series

Ls VS Current (25°C)

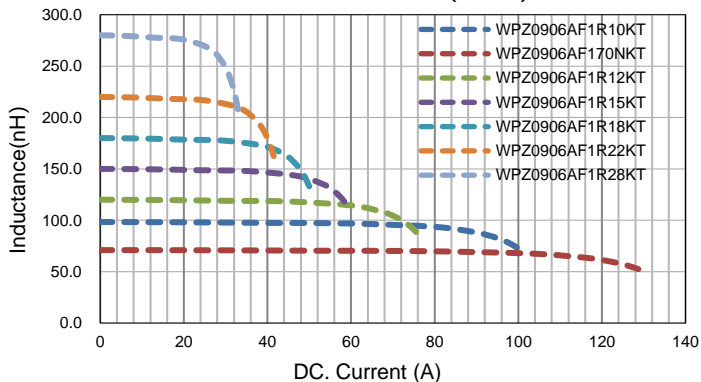

Temp VS Current

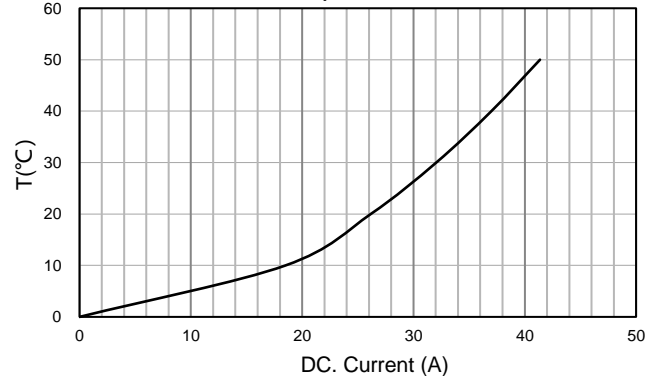

TYPICAL ELECTRICAL CHARACTERISTICS

WPZ09074S1 Series

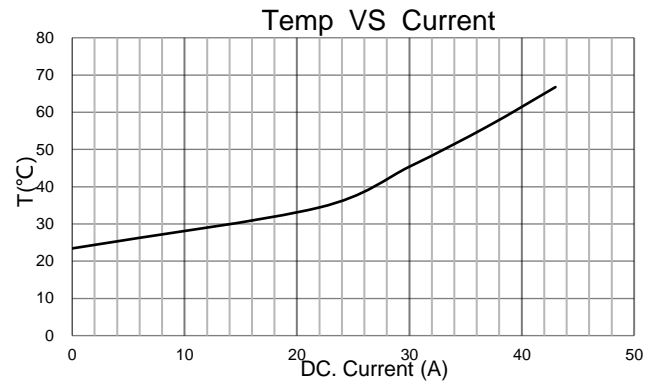
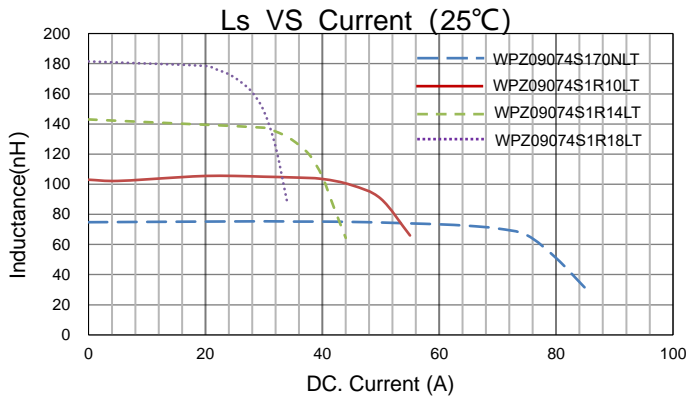

WPZ09079S1 Series

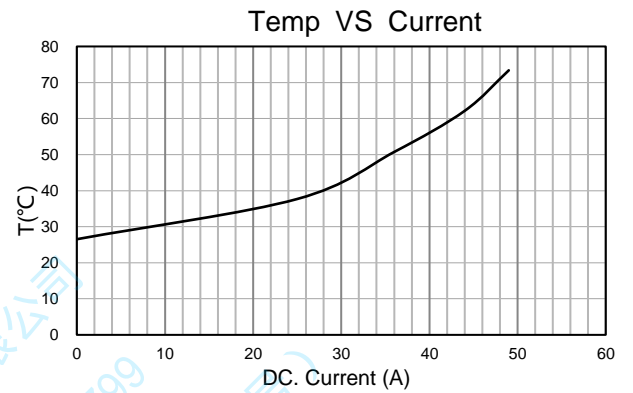
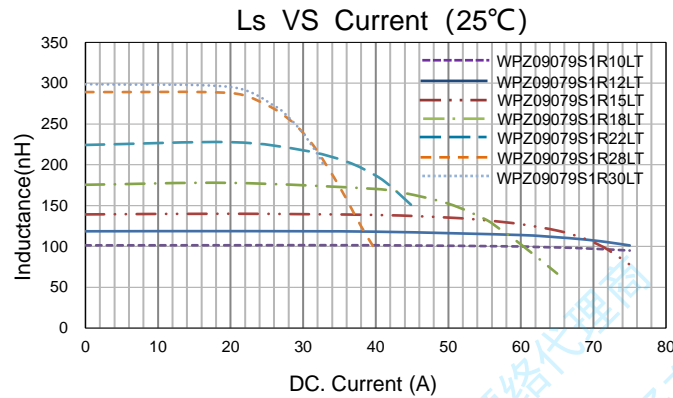

WPZ1006CB1 Series

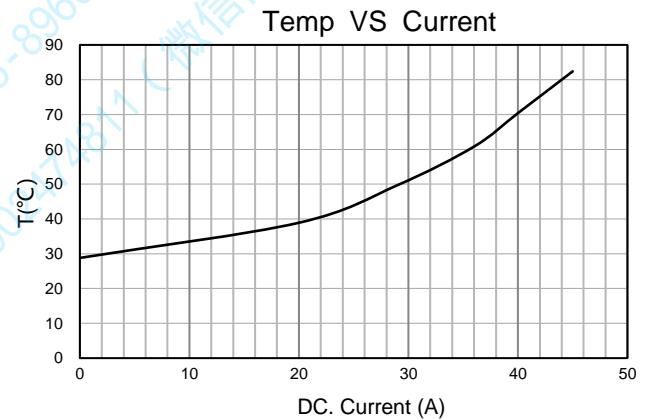
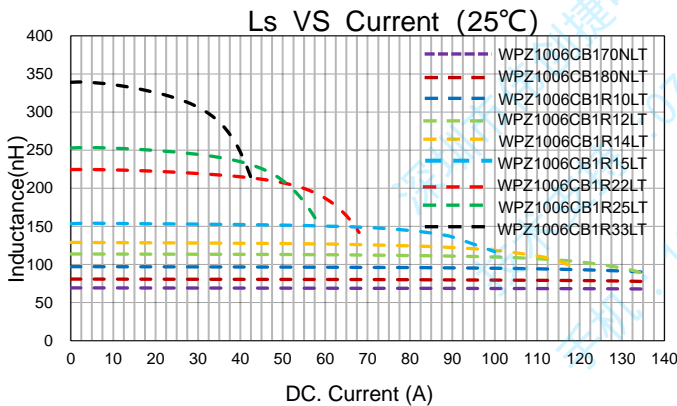

WPZ1006CS1 Series

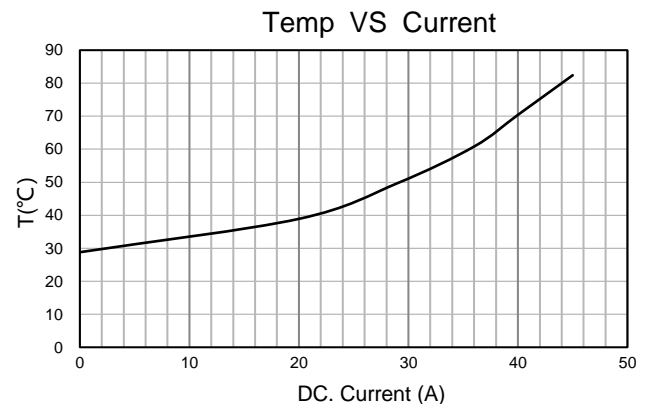
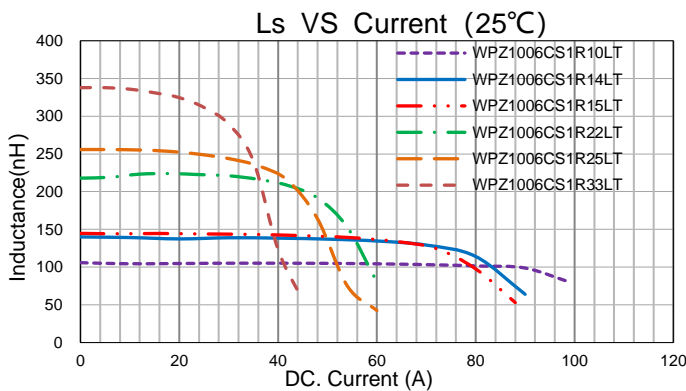

TYPICAL ELECTRICAL CHARACTERISTICS

WPZ10075B1 Series

Ls VS Current (25°C)

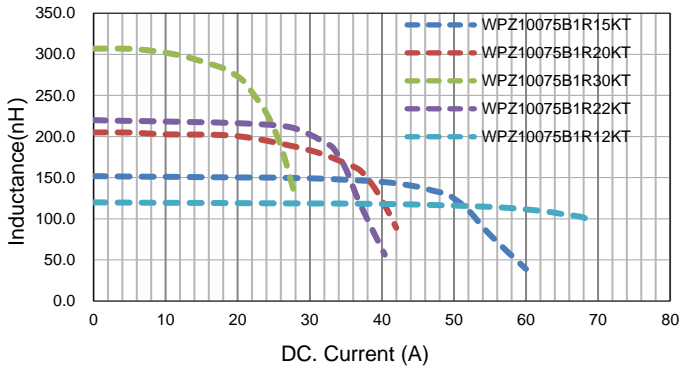

Temp VS Current

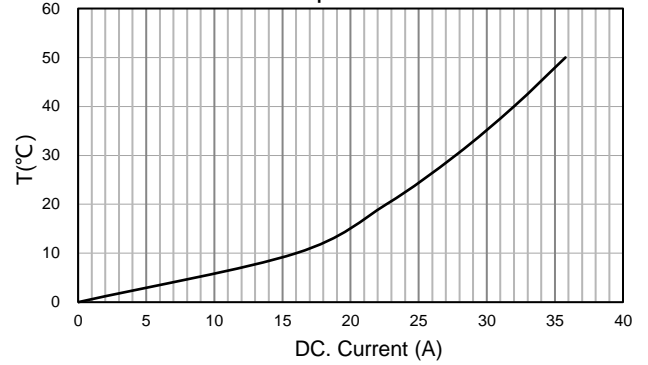

WPZ10075S1 Series

Ls VS Current (25°C)

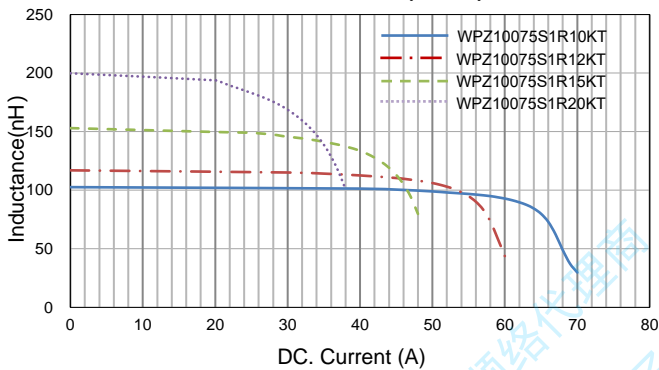

Temp VS Current

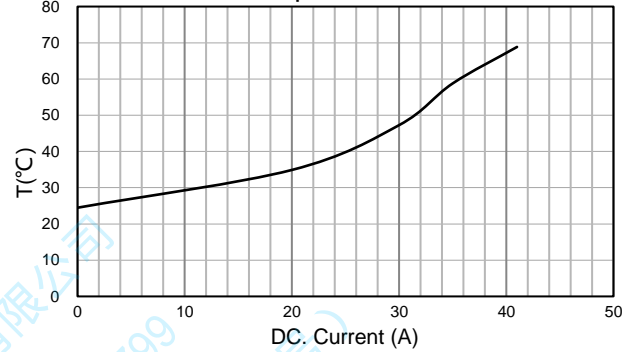

WPZ10075M1 Series

Ls VS Current (25°C)

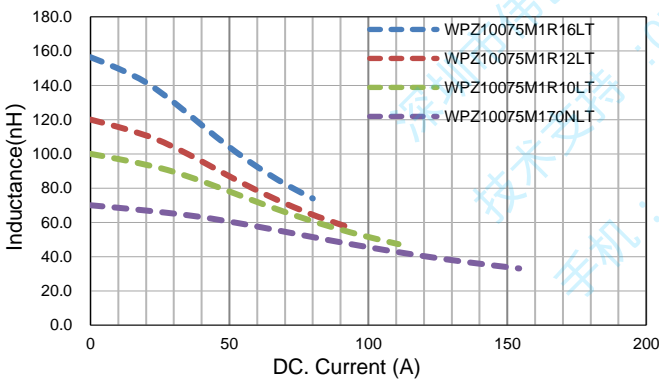

Temp VS Current

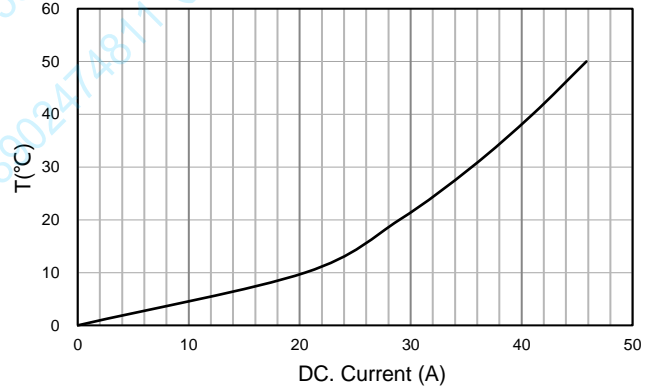

WPZ1007AS1 Series

Ls VS Current (25°C)

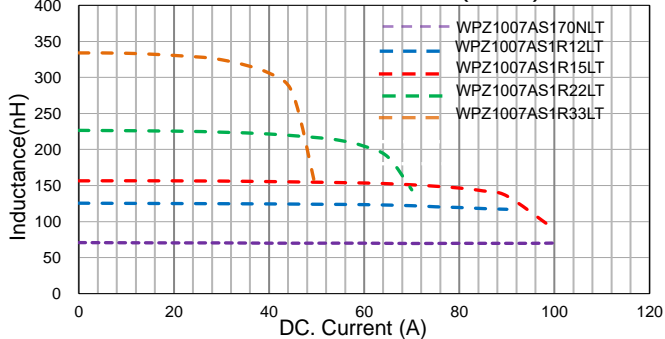

Temp VS Current

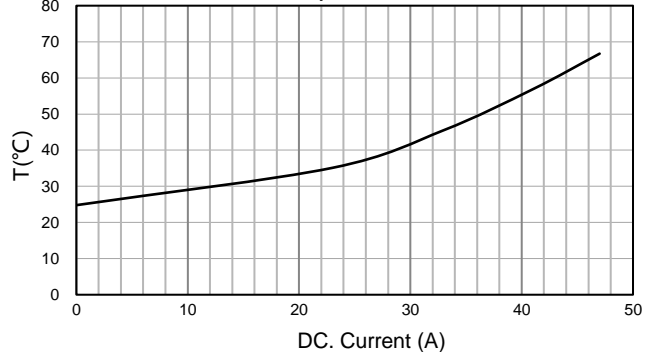

TYPICAL ELECTRICAL CHARACTERISTICS

WPZ1007CS1 Series

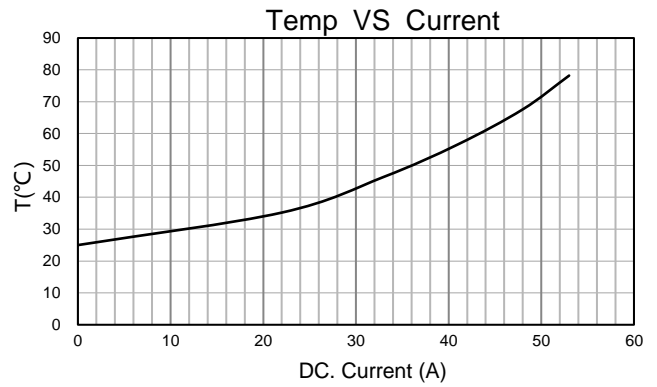
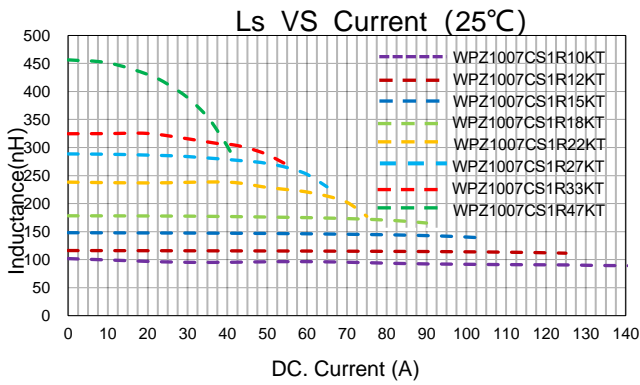

WPZ10087S1 Series

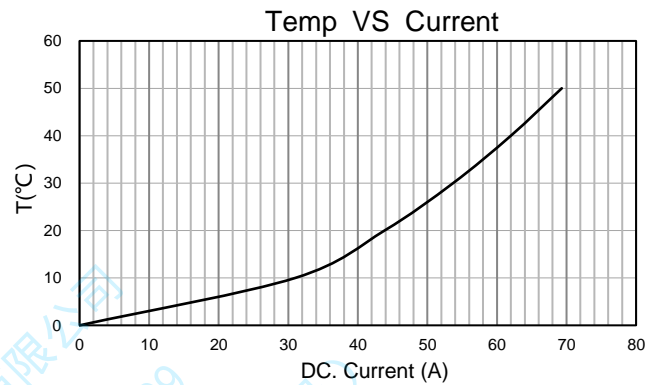
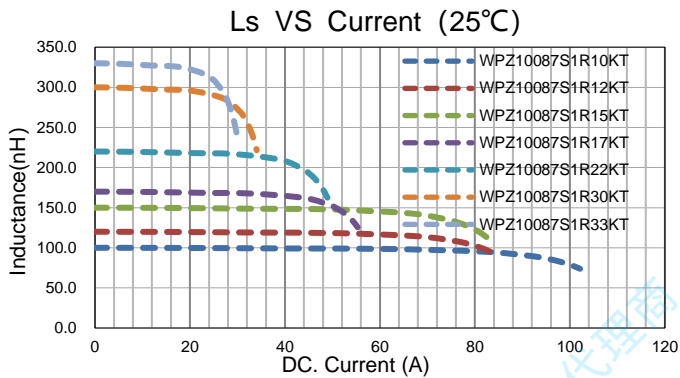

WPZ10087B1 Series

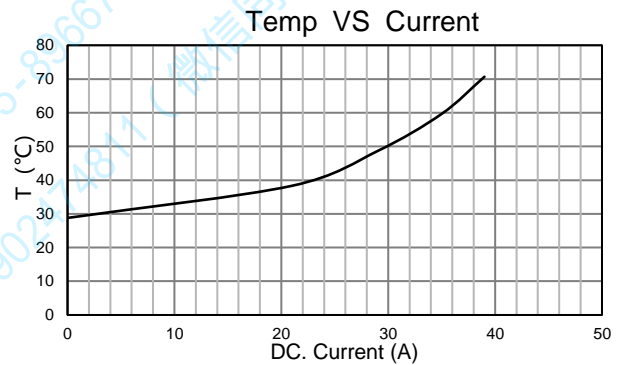
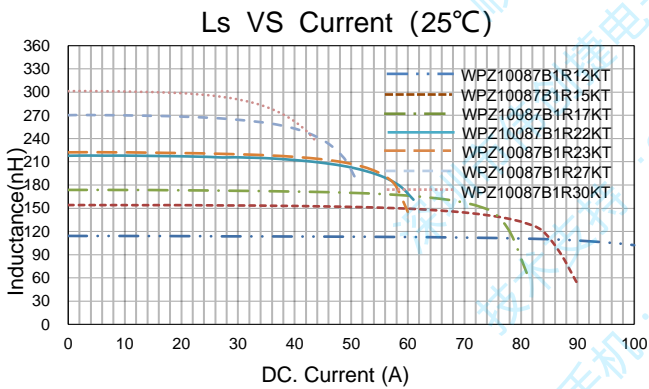

WPZ10088S1 Series

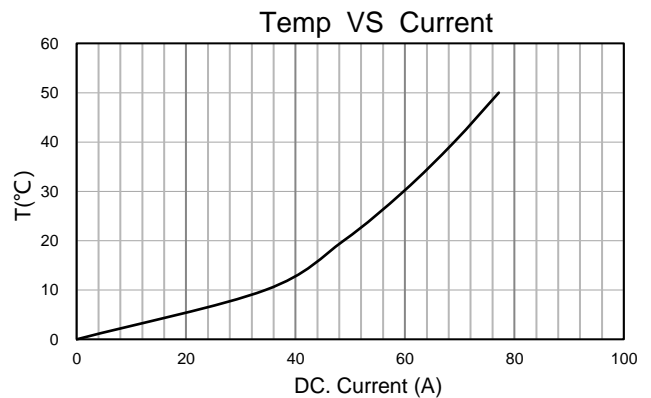
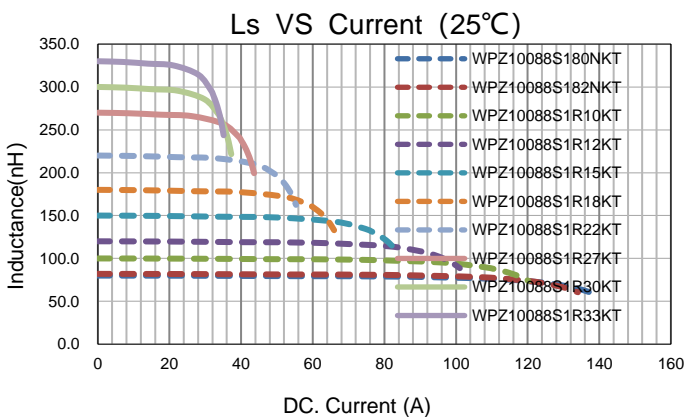

TYPICAL ELECTRICAL CHARACTERISTICS

WPZ11068S1 Series

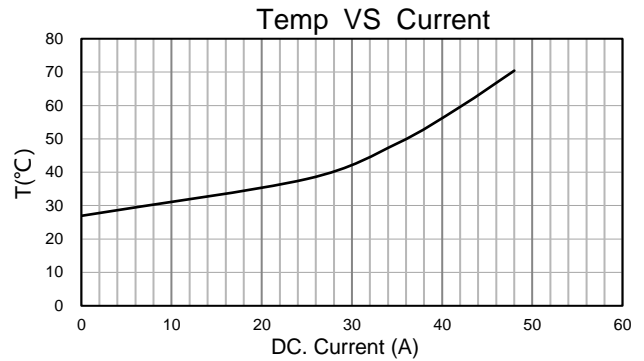
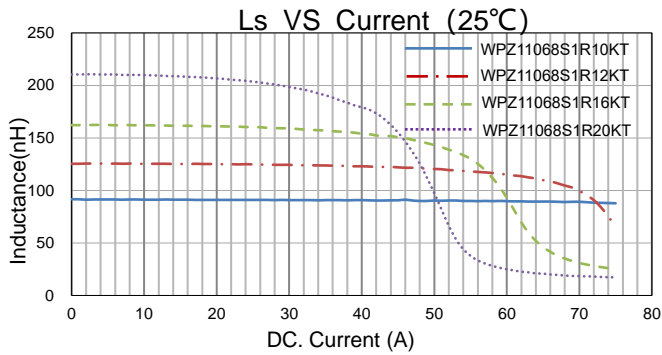

WPZ11077S1 Series

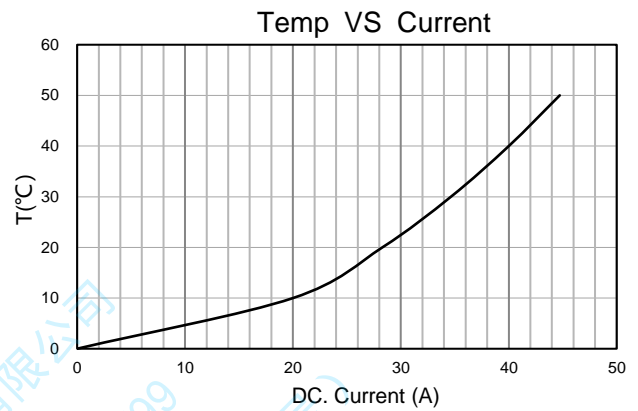
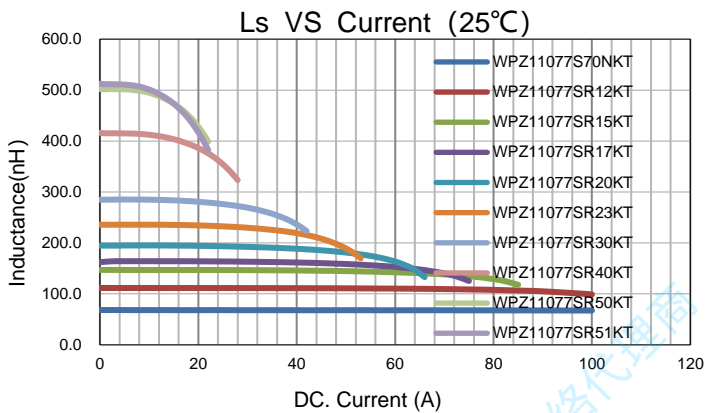

WPZ11119S1 Series

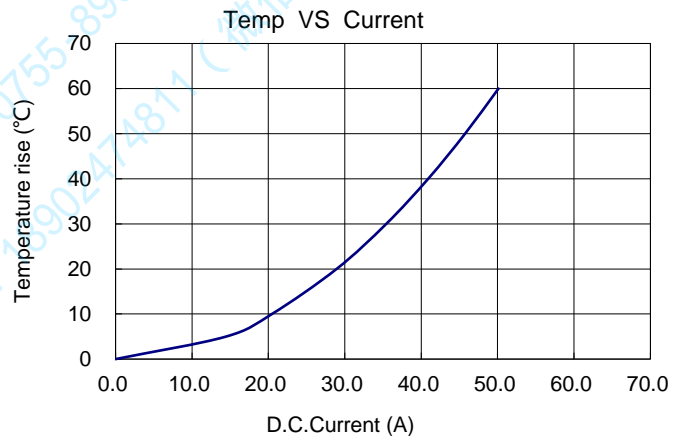
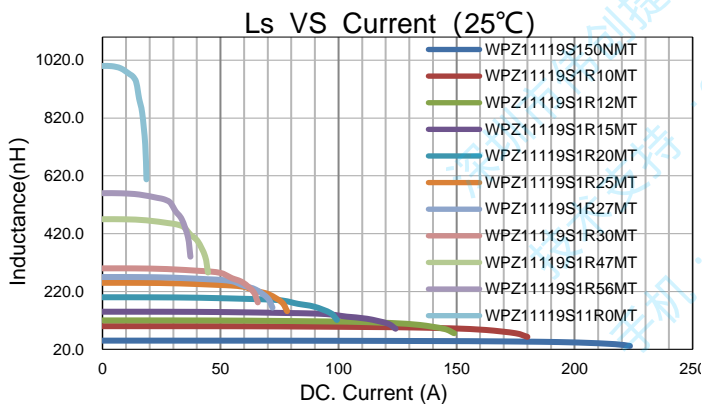

WPZ13083S1 Series

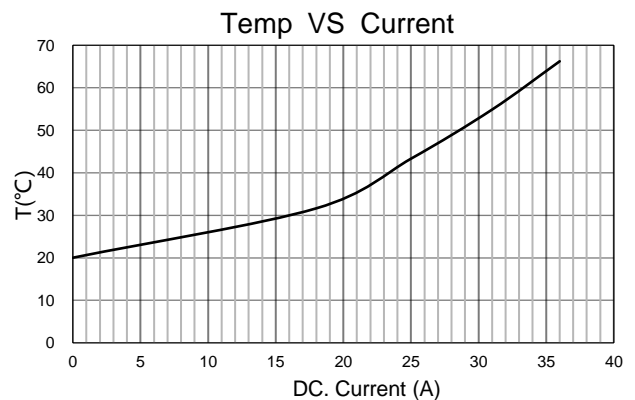
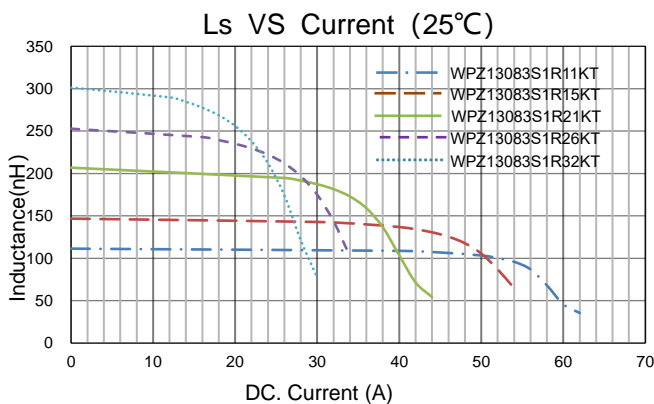

TYPICAL ELECTRICAL CHARACTERISTICS

WPZ13138S1 Series

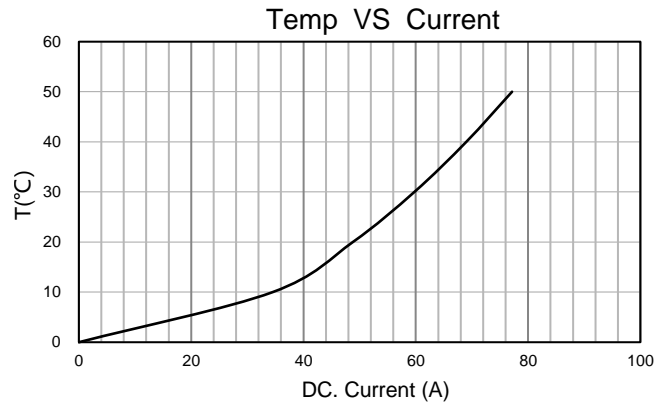
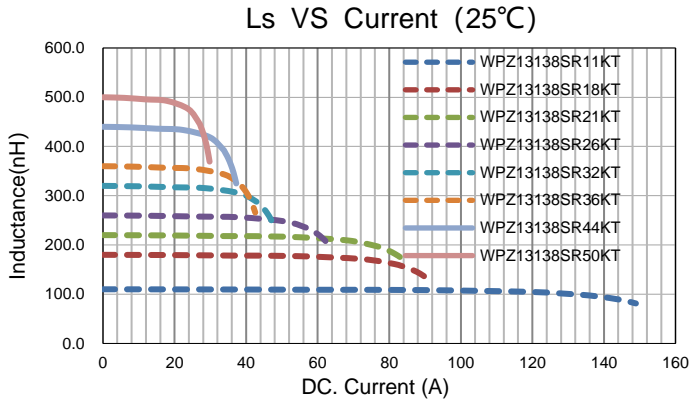

WPZ06065S1 Series

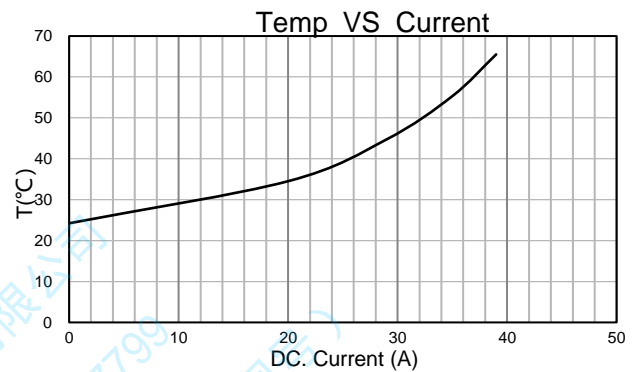
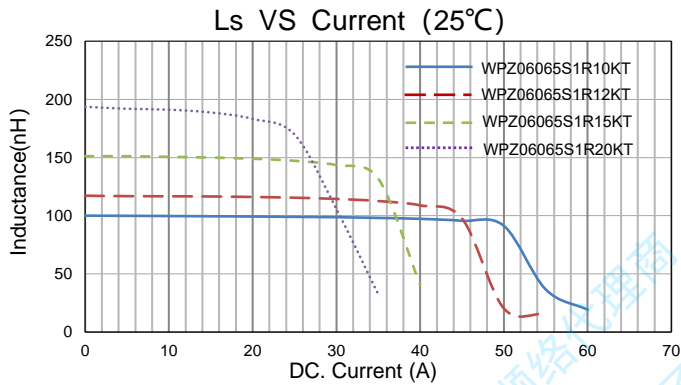

WPZ10103S1 Series

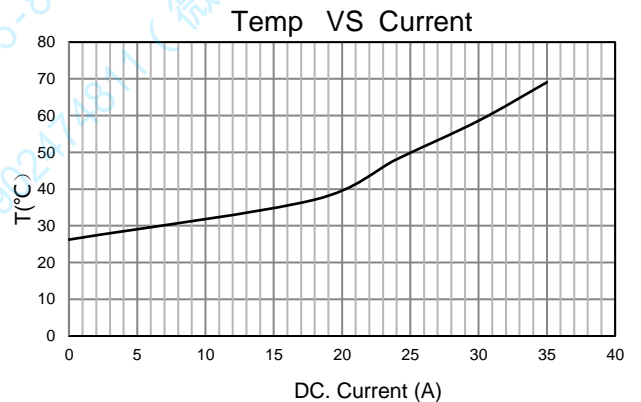
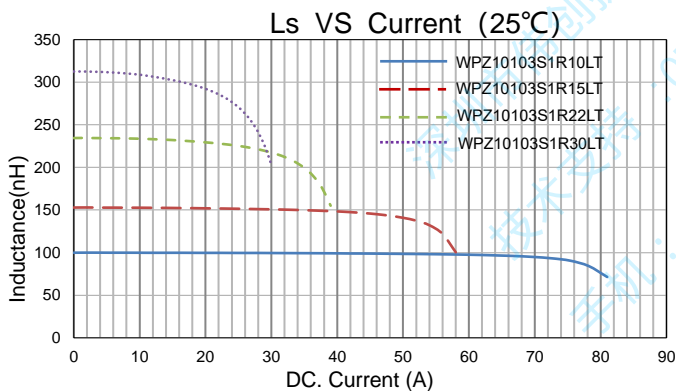

WPZ10106S1 Series

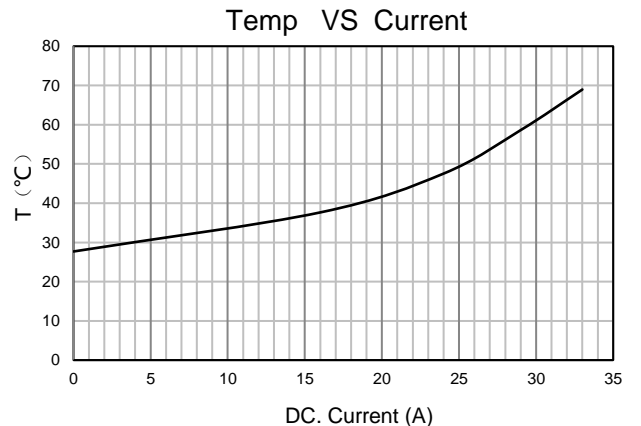
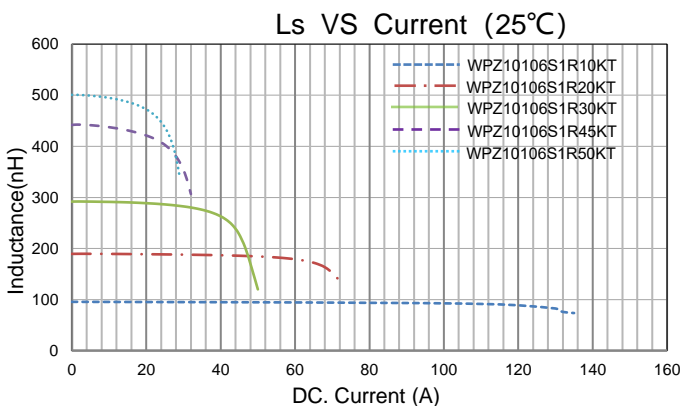

TYPICAL ELECTRICAL CHARACTERISTICS

WPZ16123S1 Series

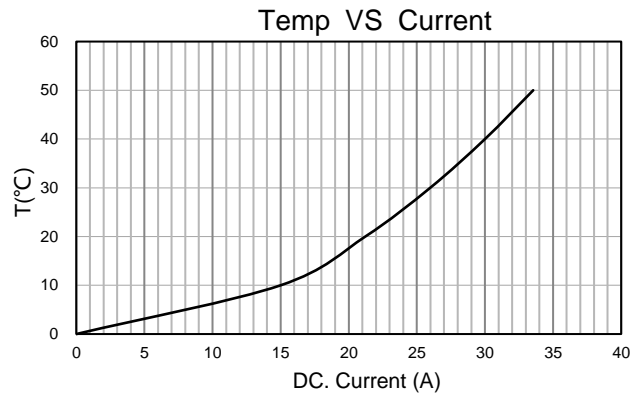
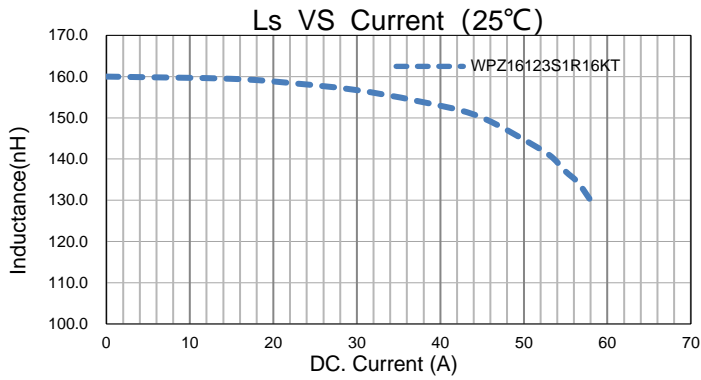

WPZ18113S1 Series

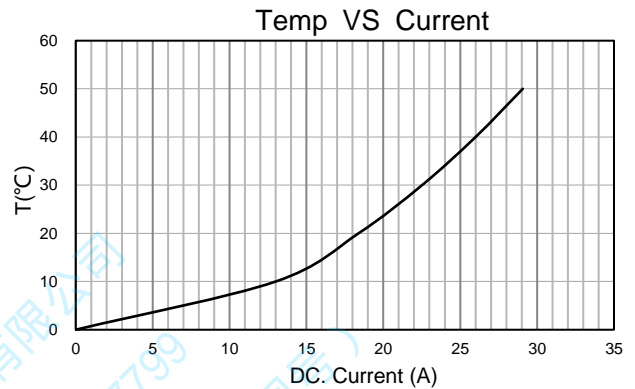
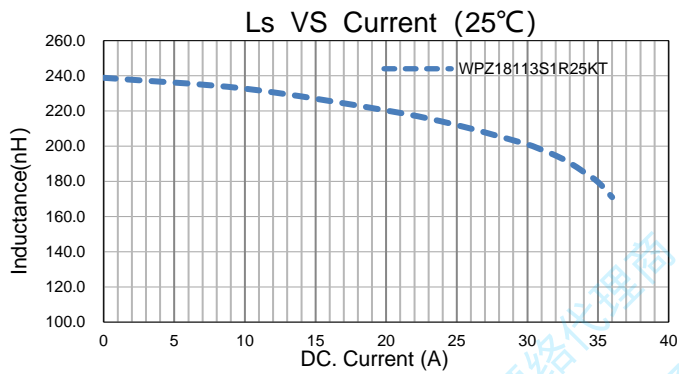

WPZ0906AS2 Series

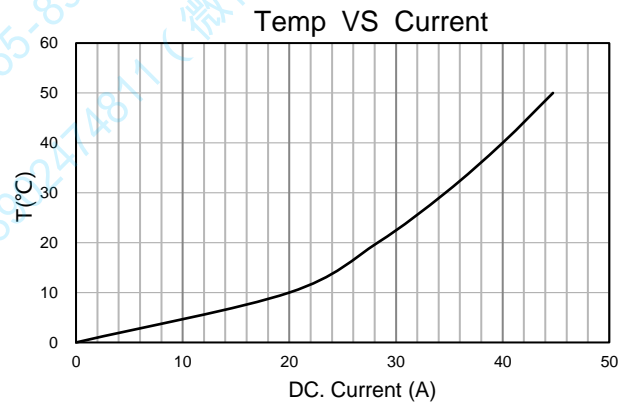
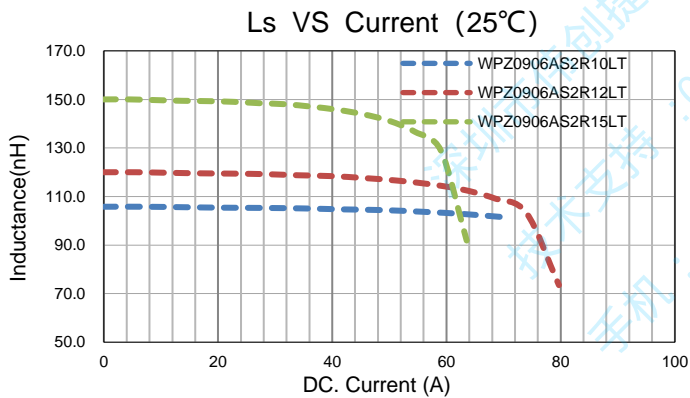

WPZ0906BS2 Series

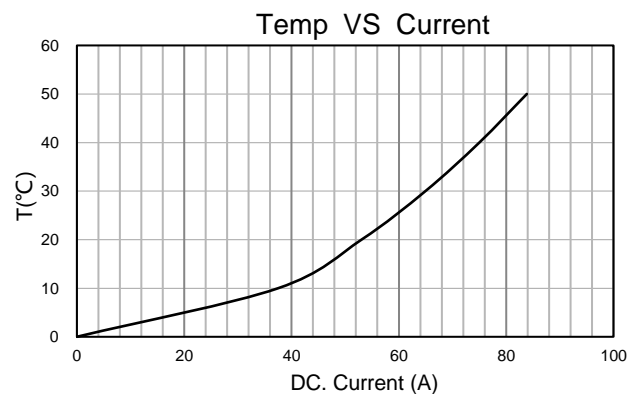
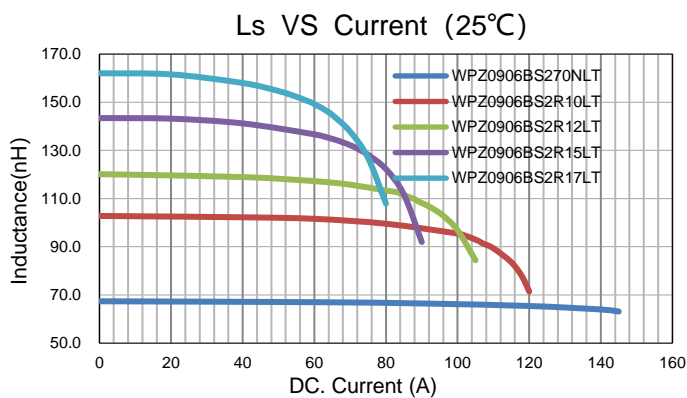

TYPICAL ELECTRICAL CHARACTERISTICS

WPZ1205CS2 Series

Ls VS Current (25°C)

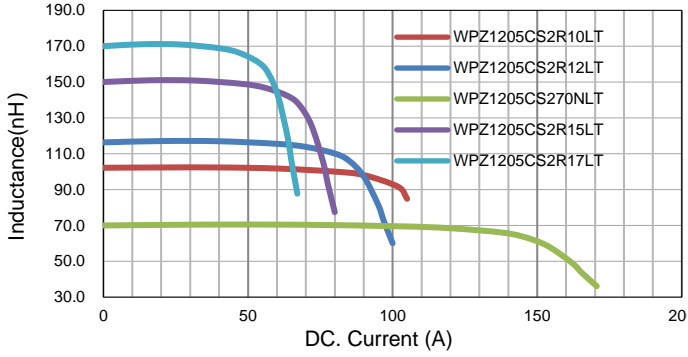

Temp VS Current

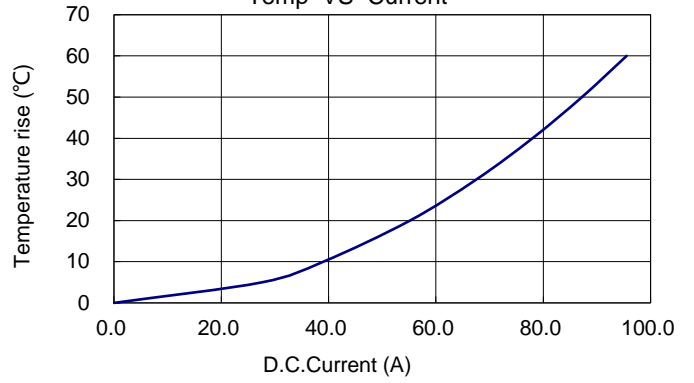

WPZ1206BS2 Series

Ls VS Current (25°C)

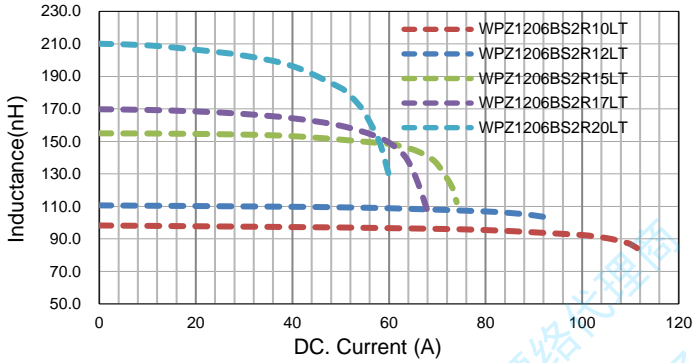

Temp VS Current

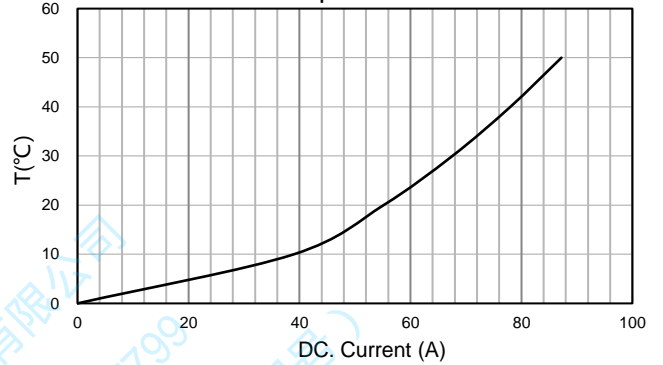

WPZ1206CS2 Series

Ls VS Current (25°C)

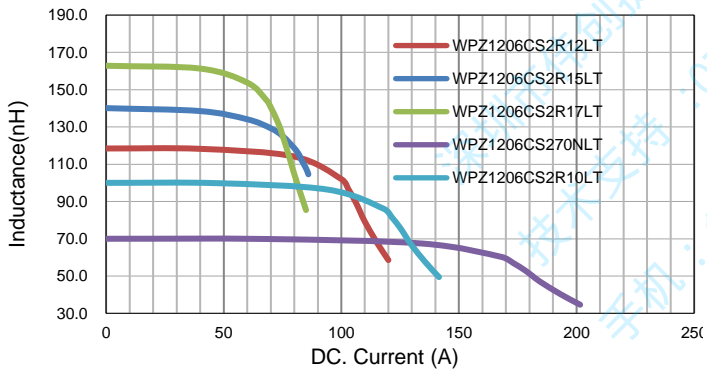

Temp VS Current

